



SCHNIER



smart-E 310/510

HIGH-VOLTAGE-SUPPLY

Part. N°: 810366, 810368, 810370, 810372, 810376, 810377, 810378,
810394, 810395, 810399, 810400, 810401, 810402, 810403

OPERATING MANUAL

Table of Contents

1. Product and Manufacturer	4
1.1. Product description	4
1.2. Designation	4
1.4. Block diagram	5
1.4.2. Option with Discharger	5
1.5. Specifications	6
1.6.2. Supply with discharger	7
1.7. Warranty	7
1.8. Manufacturer	7
2. Guide to this Operating Manual	8
2.1. Accessibility to the operating manual / Storing	8
2.2. Industrial safety symbols and phrases	8
3. Intended Use	9
3.1. Service life	10
3.2. Further requirements for the surrounding system	10
3.3. Special instructions from the product standards	11
4. Installation	12
4.1. Overview	12
4.2. Mounting	15
4.3. Dimensional drawings	17
5. Electrical connection	19
5.2. HS-Erzeuger mit CAN-BUS-Schnittstelle	20
5.3.1. Bus connection	21
5.3.2. Supply connection	21
5.4. Grounding	22
5.5. High Voltage Connection	22
6. LED indicators	23
7. Operation	24
7.1. Safety instructions for operation, service and repair	24
7.2. Generation of high voltage	25
7.3. Switching on high voltage	25
7.4. Switching off high voltage	25
7.5. Voltage and current control	25
7.5.1. Constant voltage operation	26
7.5.2. Constant current operation	27
7.6. Dynamic switch off di/dt	28
7.7. Electrical arc detection	28
7.8. Monitoring residual energy	28
7.8.1. Functional description	28
7.8.2. Safety relevant details	29
7.9. Operating Mode of the integrated discharger	30
Specification of the fieldbus interfaces	31
8. Specification of the CAN-bus-interface	31
8.1. Bus interface	31
8.2. Application interface	31

8.2.1.	EDS-Files	31
8.2.2.	Control of the generator via CAN open	31
8.2.3.	Structure and content of the PDOs	32
8.2.4.	An example of the controls of the PDOs	32
8.2.5.	Object directory	34
8.2.6.	Bit map	35
8.2.7.	Describing the control word	36
8.2.8.	Description of the status word	36
9.	PROFINET interface specifications	38
9.2.	Application interface	38
9.2.1.	GSD-Files	38
9.2.2.	Write the data sets (record writes)	38
9.2.3.	Receive I/O data mapping (PN-IO controller to PN-IO device)	39
9.2.4.	I/O data mapping transfer: (PN-IO device to PN-IO controller)	39
9.2.5.	I/O data definition (area, unit, standard)	39
9.2.6.	Describing the control word	40
9.2.7.	Description of the status word	41
10.	Specification of the Ethernet/IP interface	43
10.1.	Bus interface	43
10.2.	Application interface	44
10.2.1.	Receive I/O data mapping (EIP controller to Smart-E510)	44
10.2.2.	I/O data mapping transfer: (Smart-E510 to EIP-Controller)	44
10.2.3.	I/O data definition (area, unit, standard)	44
10.2.4.	Describing the control word	45
10.2.5.	Description of the status word	46
11.	Specification of the EtherCAT interface	48
11.1.	Bus interface	48
11.2.	Application interface	48
11.2.1.	ESI files	48
11.2.2.	Receive I/O data mapping (EtherCAT Master to Smart-E510)	48
11.2.3.	I/O data mapping transfer: (Smart-E510 to EtherCAT Master)	48
11.2.4.	I/O data definition (area, unit, standard)	49
11.2.5.	Describing the control word	50
11.2.6.	Description of the status word	51
12.	Declaration of Conformity	53

1. Product and Manufacturer

1.1. Product description

The smart-E 310 or smart-E 510 is a compact **all-in-one** high voltage supply for electrostatic applications. Only a 24 V supply and a fieldbus connection are required for operation. The installed microcontroller enables a very precise and fast control of the HV output voltage.

Inside the smart-E310 or smart-E 510 are the **HV generator, HV controls and a residual energy monitoring system** all combined into one device. The conventional external HV control is completely omitted.

Latest version devices also provide **performance level d** for residual energy monitoring. These new devices are recognizable by their designation, due to the addition of: ISO 13849-1:2008 Category 3 PL d.

The smart-E 310 or smart-E 510 has **separate 24 V supplies** for the **CPU** and for HV generation. Thus, communication via the bus can be maintained, even if the energy supply of the HV generator is disconnected, for example to free access to the high voltage carrying parts.

There is for all Ethernet based HV-supplies an option with an integrated discharger. This electronic discharger accelerates the discharging process less than one second, in dependency of the cabin capacity.

1.2. Designation

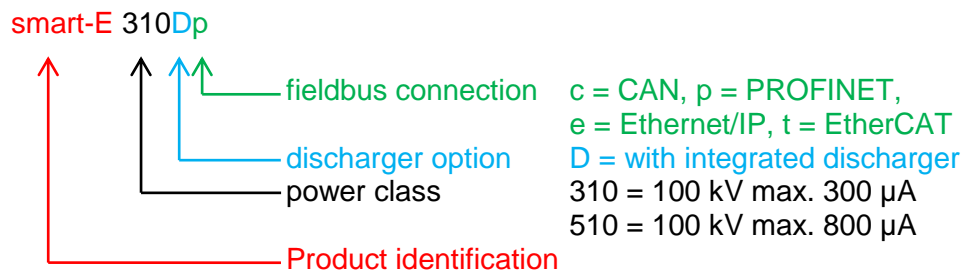

1.3. Product identification

Item no.	Type	100 kV / 300 µA	100 kV / 800 µA	Fieldbus	Discharger
810366	smart-E 310p	X		PROFINET	No
810368	smart-E 310c	X		CAN	No
810370	smart-E 510p		X	PROFINET	No
810372	smart-E 510e		X	Ethernet/IP	No
810376	smart-E 510t		X	EtherCAT	No
810377	smart-E 310t	X		EtherCAT	No
810378	smart-E 510c		X	CAN	No
810394	smart-E 310Dp	X		PROFINET	Yes
810395	smart-E 510Dp		X	PROFINET	Yes
810399	smart-E 510Dt		X	EtherCAT	Yes
810400	smart-E 310Dt	X		EtherCAT	Yes
810401	smart-E 310e	X		Ethernet/IP	No
810402	smart-E 310De	X		Ethernet/IP	Yes
810403	smart-E 510De		X	Ethernet/IP	Yes

1.4. Block diagram

1.4.1. Option without Discharger

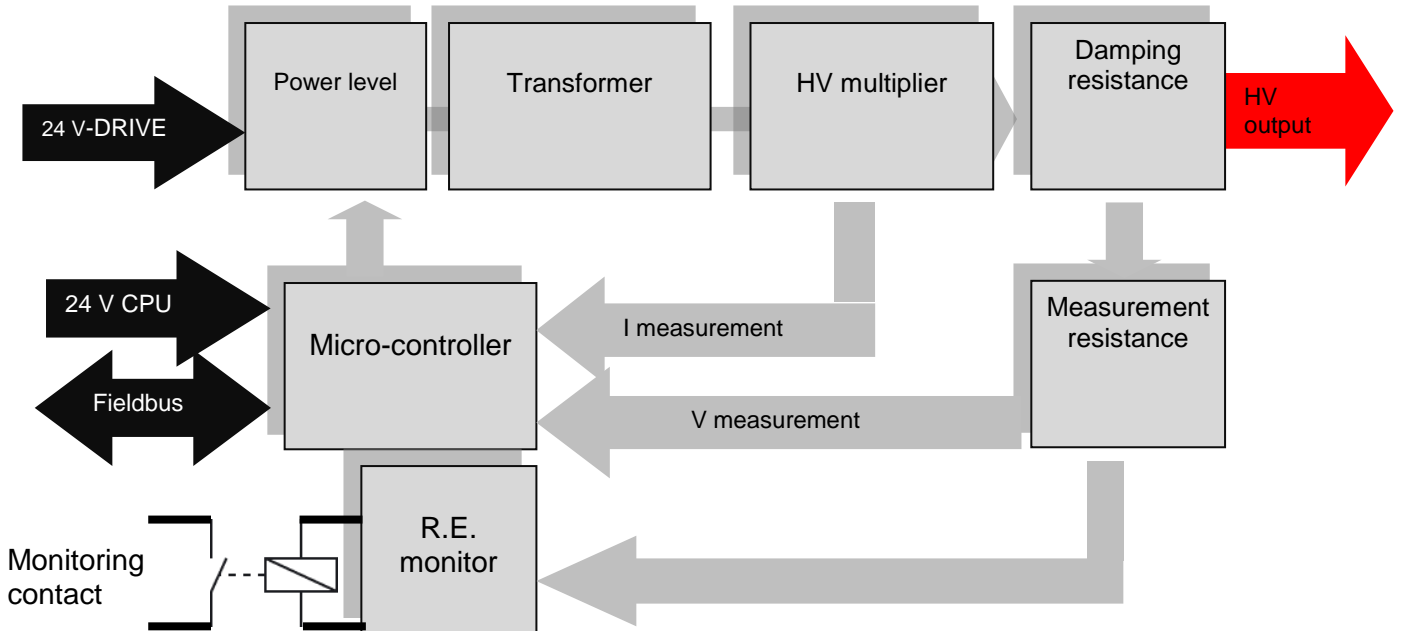

1.4.2. Option with Discharger

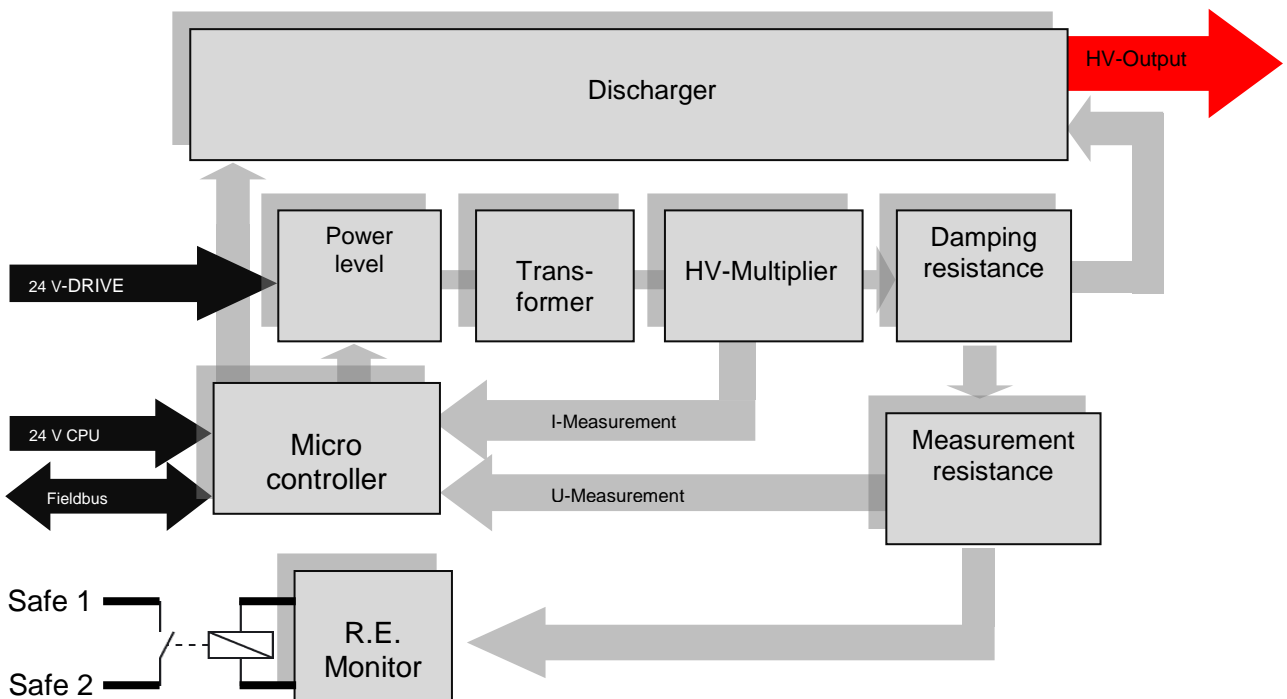

1.5. Specifications

	smart-E 310	smart-E 510
Supply voltage DRIVE	24 V DC (+/- 10 %) max. 2 A fuse max. 4A	24 V DC (+/- 10 %) max. 4 A fuse max. 4A
Supply voltage CPU	24 V DC (+/- 10 %) max. 1 A fuse max. 4 A	24 V DC (+/- 10 %) max. 1 A fuse max. 4 A
Output voltage	10-100 kV negative	
Output current	300 µA	600 µA* ¹ (bis 80 kV: 800 µA)* ¹
Maximal system capacity	120 pF (200 pF with Dis- charger)	220 pF (300 pF with Dis- charger)
Environment	+15 °C bis 40 °C max. 70 % rel. humidity, not condensing	
Storage temperature	-20 °C - +70 °C	
Dimensions	See 4.3	
Weight without Discharger	max. 3,5 kg	max. 4,5 kg
Weight with Discharger	max. 5 kg	max. 6 kg
Protection class	IP 65	
HV-Connection without Dis- charger	Output with 4 mm HS-connector socket	
HV-Connection with Dis- charger	High-voltage cable installed in insulation grease	
Fieldbus interface	CAN* ² , PROFINET, Ethernet/IP, EtherCAT	
LED signals	Supply, HV status, network (traffic, link)	
Residual energy monitoring	Performance Level PL d	
Monitoring contact	Potential free positively driven 24 V relay contact. Information for Performance Level, see Fehler! Verweisquelle konnte nicht gefunden werden.	
* ¹ : As of SW Version 3.0. previously 500 uA		
* ² : CAN not available with discharger		

1.6. Product designation

1.6.1. Supply without discharger

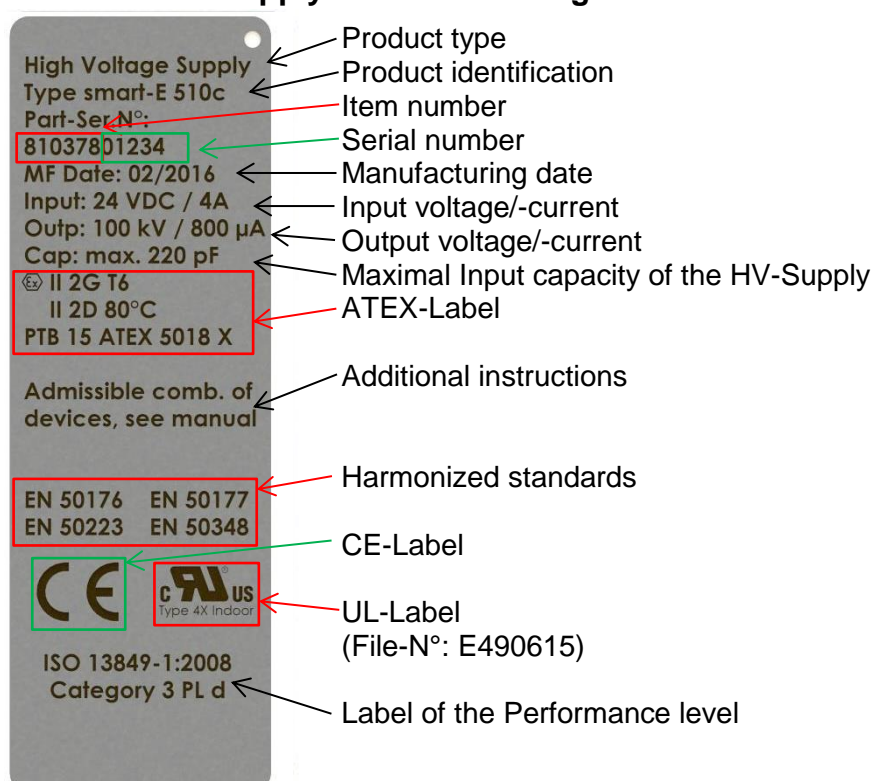

1.6.2. Supply with discharger

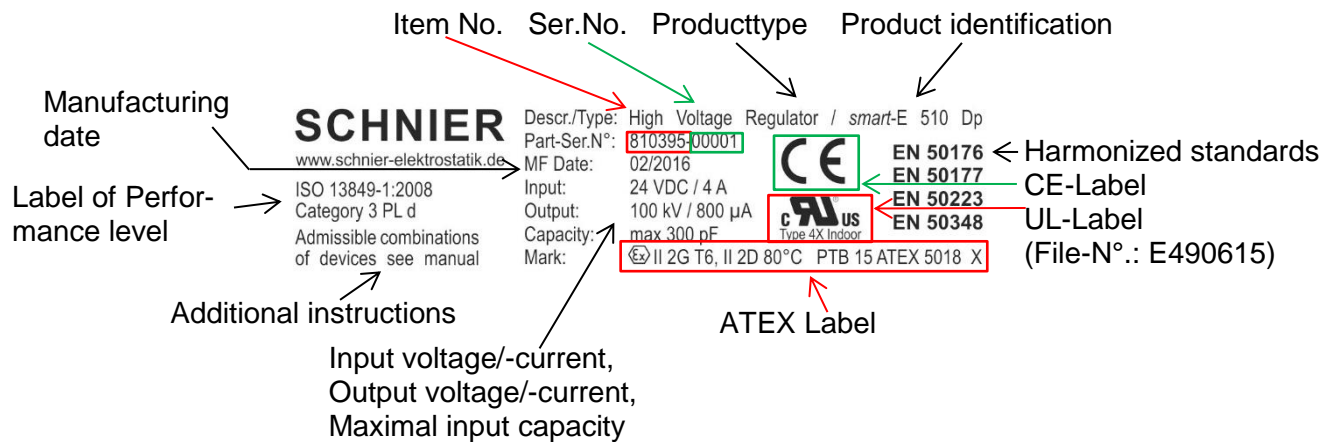

1.7. Warranty

All warranties are void if the device is opened, modified, parts not replaced with the original parts or if this operating manual is not observed.

1.8. Manufacturer

SCHNIER Elektrostatik GmbH
 Bayernstr.13
 72768 Reutlingen
 Germany

Tel: +49 (0) 71 21 / 90 973 -60
 Fax: +49 (0) 71 21 / 90 973 -99
 mail@schnier-elektrostatik.de
 www.schnier-elektrostatik.de

Managing director: Olav Schnier
 Head office: Reutlingen
 HBR 354 531
 VAT ID No.: DE 146 481 986
 ISO 9001:2008 certified

2. Guide to this Operating Manual

This operating manual must be read, understood and observed in all points by all persons that have responsibility for the devices and electrostatic systems. Only with knowledge of this operating manual can errors be avoided and operation that is safe and free of malfunctions can be guaranteed. SCHNIER Elektrostatik GmbH assumes no liability for damage that occurs due to non-compliance with this operating manual!

This operating manual is valid for:

Installation and service personnel (e.g., machine installers, IT specialists, electrically qualified persons), who are trained by the manufacturer or operating company regarding this manual and the corresponding safety regulations.

Operating personnel (e.g., machine installers, IT specialists, persons with electrical qualifications), who are trained by the manufacturer or operating company regarding this manual and the corresponding safety regulations.





2.1. Accessibility to the operating manual / Storing

The operating manual must always be available and easily accessible at the unit for the responsible specialist personnel (operators, service and maintenance personnel).

The operating manual must be kept by the operating company during the entire service life of the unit. In case of a resale of the unit or of unit parts, the operating manual must be handed over to the new owner, since it is a part of the system.

2.2. Industrial safety symbols and phrases

Note: The phrase "parts under live power" or "active parts" in this operating manual stand for "parts, which have a high-voltage potential during normal operation".

Symbol	Effect
	This symbol warns against potential hazardous situations that can lead to death or injury if they are not prevented.
	This symbol warns against potential hazardous electrical shocks that can lead to death or injury if they are not prevented.
	Warning of damage to the system or operational malfunctions.
	Hints for easy, rational proceeding.

3. Intended Use

These devices are intended for use in stationary electrostatic application equipment for coating to product standards:





EN 50176:2009 Stationary electrostatic application equipment for ignitable liquid coating material

EN 50177:2009 Stationary electrostatic application equipment for ignitable coating powders

EN 50223:2015 Stationary electrostatic application equipment for ignitable flock material

EN 50348:2010 + Cor:2010 Stationary electrostatic application equipment for nonignitable liquid coating material

This high-voltage generator is a device of category **2G or 2D** for use in potentially explosive areas of **Zone 1 or 21**. The high-voltage generator must only be used in potentially explosive atmospheres, which are themselves generated through the spray cloud of the processed coating material.

	<p>CAUTION The respective type of electrostatic spraying equipment is to be determined on the basis of their EU-Type Examination Certificate in assembly with the high-voltage control “smart-E”.</p>
	<p>CAUTION It is to ensure by inspection prior to commissioning and periodic testing that the values of the output current and the output voltage of the electrostatic spraying equipment referred in the EU-Type Examination Certificate are not exceeded.</p>
	<p>CAUTION It is to ensure by inspection prior to commissioning and periodic testing that the requirements of 5.3.1, 6.3.3.2, 6.3.4.2, 6.3.5, 6.3.6 and 6.4 of EN 50176:2009 respectively the relevant requirements of EN 50177:2009, EN 50223:2010 or EN 50348:2010 are fulfilled.</p>
	<p>CAUTION Every start up outside of this regulation is prohibited.</p>
	<p>CAUTION The device may not be changed.</p>
	<p>Operation, installation and service work must only be performed by sufficiently trained personnel.</p>





This device must not be used alone. It may only be put into operation after complete and proper installation and if it is detected that the system in which the device will be installed corresponds totally to the regulations of the above mentioned product standards. The details of this operating manual must be complied with.

3.1. Service life

The service life is set to a maximum of **20 years**, since this value is based on the methods in EN 13849. In addition, Performance Level d does not apply to residual energy monitoring.

Obvious defective devices must be shut down immediately.



3.2. Further requirements for the surrounding system

	<p>The HV generator must only be used in electrostatic systems within a temperature range of 15 °C to 40 °C and with a relative humidity between 10 % and 70 % (not condensing).</p>
	<p>The HV generator is intended for operation in a specific stationary system in an industrial. Due to the occurring conductive or radiated interferences, difficulties can possibly arrive in ensuring the electromagnetic compatibility in other environments.</p>
	<p>This enclosure provides only corrosion protection for indoor.</p>
	<p>To prevent hazards the entire system must undergo a risk analysis. Especially the Performance Level required in the above mentioned product standards for safety functions can only be met via a safety concept of the entire system.*</p>

* Since the sprayer system is connected to the high-voltage generator via a high-voltage cable, a specific Performance Level by this unit can only be ensured up to the connection point of the HV cable. The cable to the sprayer system must be considered separately.

3.3. Special instructions from the product standards

The above mentioned product standards describe the safety requirements for the stationary equipment for electrostatic coatings. For information and in the interest of safety the following sections of these standards are especially noted:

	Section	
	5.2.1 (5.3.2)	The distance between the workpiece and the parts under high-voltage must be so large that in normal operation an electrical arcing can be prevented.
	5.2.3 5.2.4 (5.3.4) (5.3.5) [5.2.3]	After switching off the high-voltage all high-voltage carrying parts must be discharged less than 350 mJ before these parts can be reached. If flammable liquids must be used for cleaning purposes, there is a valid value of 0.24 mJ .
	5.4.5 (5.5.2.3) [5.3.2]	When using walls, covers, signs and labels made of non-conducting material there is the risk of propagating brush discharges. These can occur if low thickness plastics have contact with large surface grounded conductors (e.g., metals). The dielectric strength of the coating must not exceed 4 kV .
	5.5. [(5.4)]	Description of all requirements for the high-voltage power supply which the HV generator is a part of. High-voltage must be switched off and the voltage carrying parts must be discharged to a safe voltage before intervention on parts under live power.
	5.6. (5.5.2.1) [5.5]	The electrical equipment that is not a part of the high-voltage power supply must conform to EN 60204-1.
	5.7. (5.5.2.2) [5.6.1]	All conductive components of the system, e.g., floors, transport equipment, etc., with the exception of the normal operational high-voltage carrying parts, must be grounded. The bleeder resistance may be max. 1 MΩ.

The sections refer to the corresponding standards:

- Without terminals: EN 50176:2009 and EN 50177: 2009
- () EN 50223:2015
- [] EN 50348:2010

This excerpt does not make any claim for completeness and does not replace compliance with all safety requirements from product standards!

4. Installation

4.1. Overview

4.1.1. HV-Supply with CAN-Interface

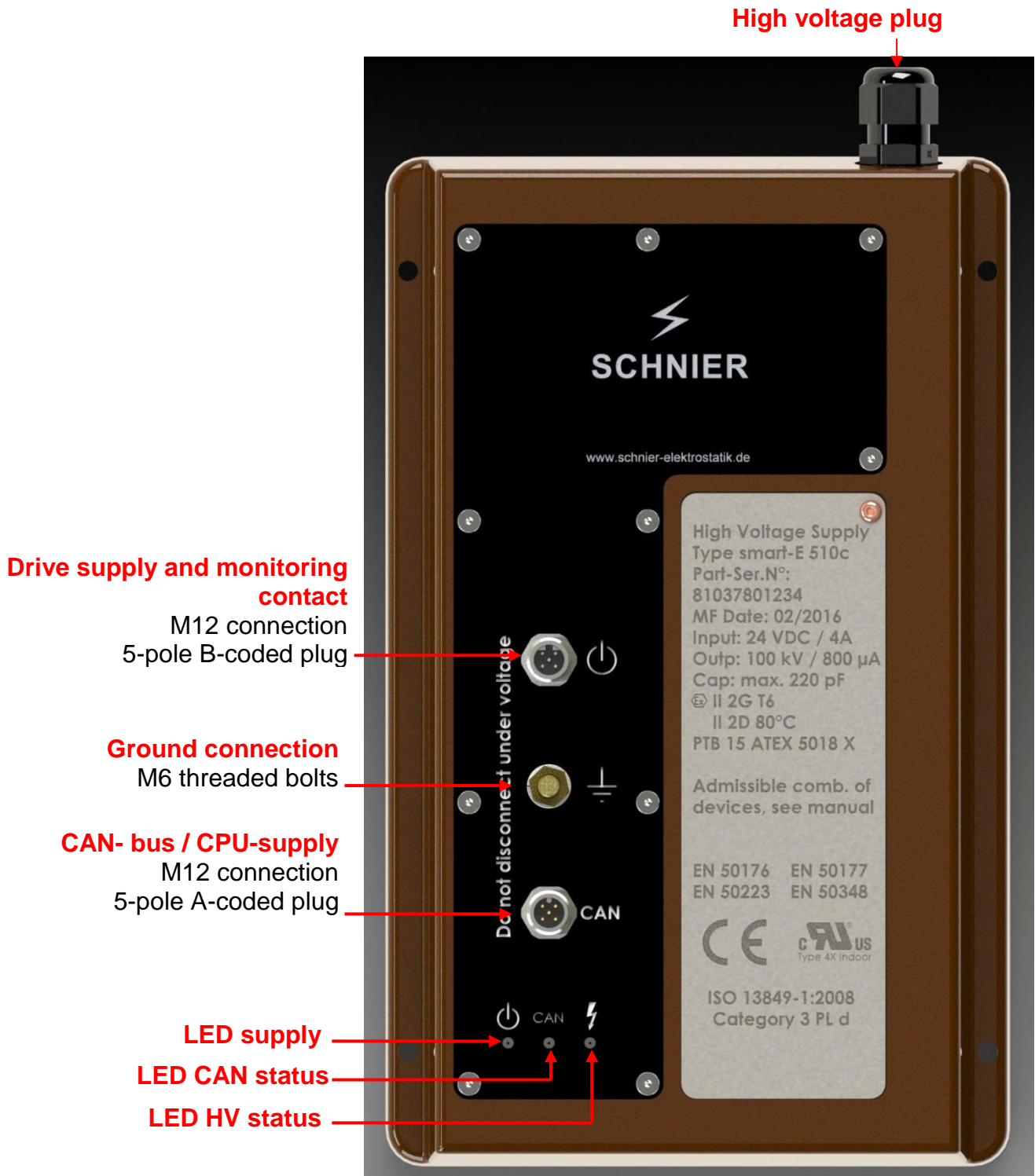

4.1.2. HV-Supply with PROFINET, Ethernet/IP or EtherCAT

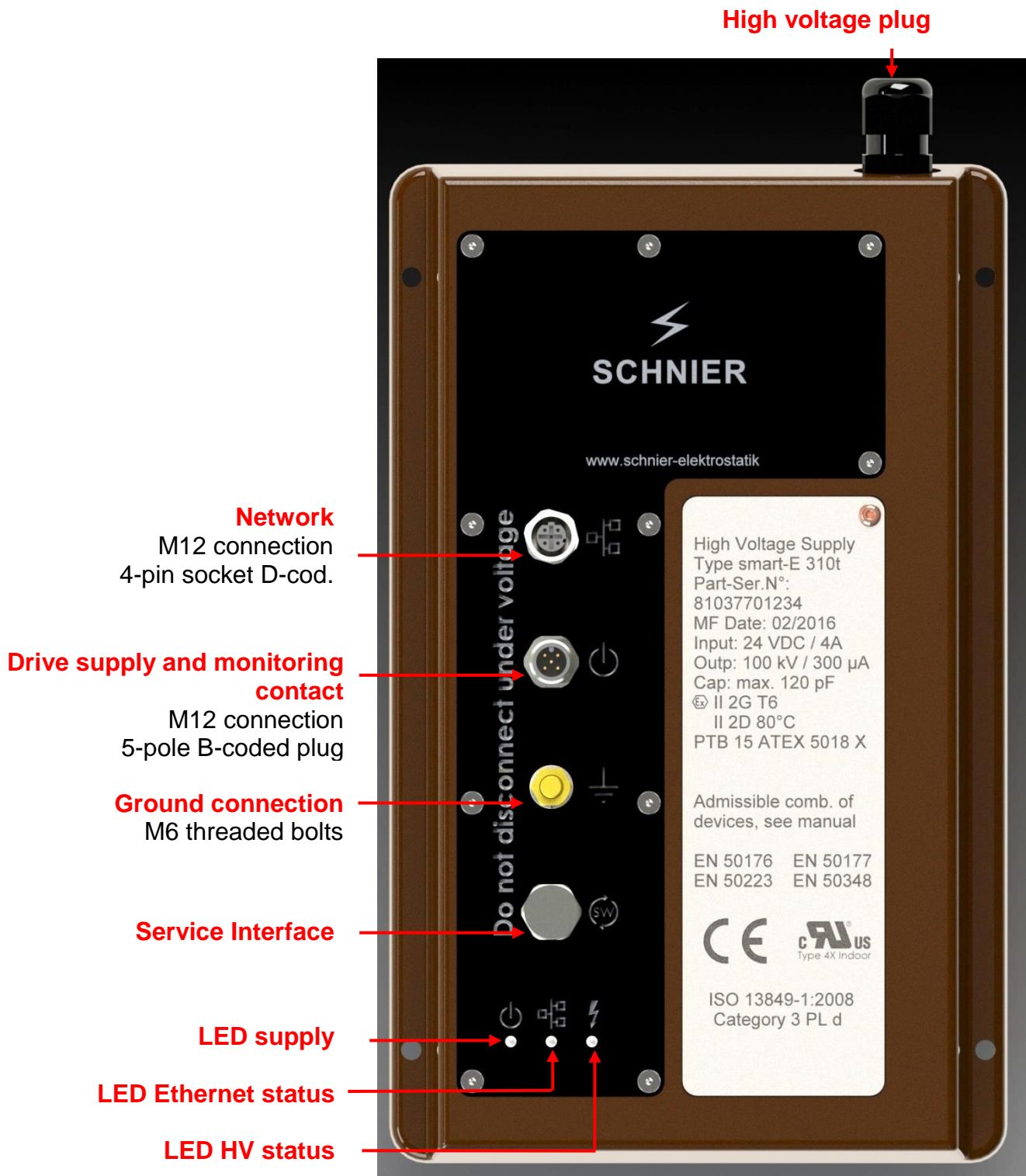

4.1.3. HV-supply with integrated discharger

High-voltage connection
 Connection between generator and discharger must only be replaced in the factory

High-voltage output
 Cable is cast in insulation grease and must be installed/replaced in the factory

- Network**
M12 connection
4-pin socket D-cod.
- Drive supply and monitoring contact**
M12 connection
5-pole B-coded plug
- Ground connection**
M6 threaded bolts
- Discharger connection**
- LED supply**
- LED Ethernet status**
- LED HV status**

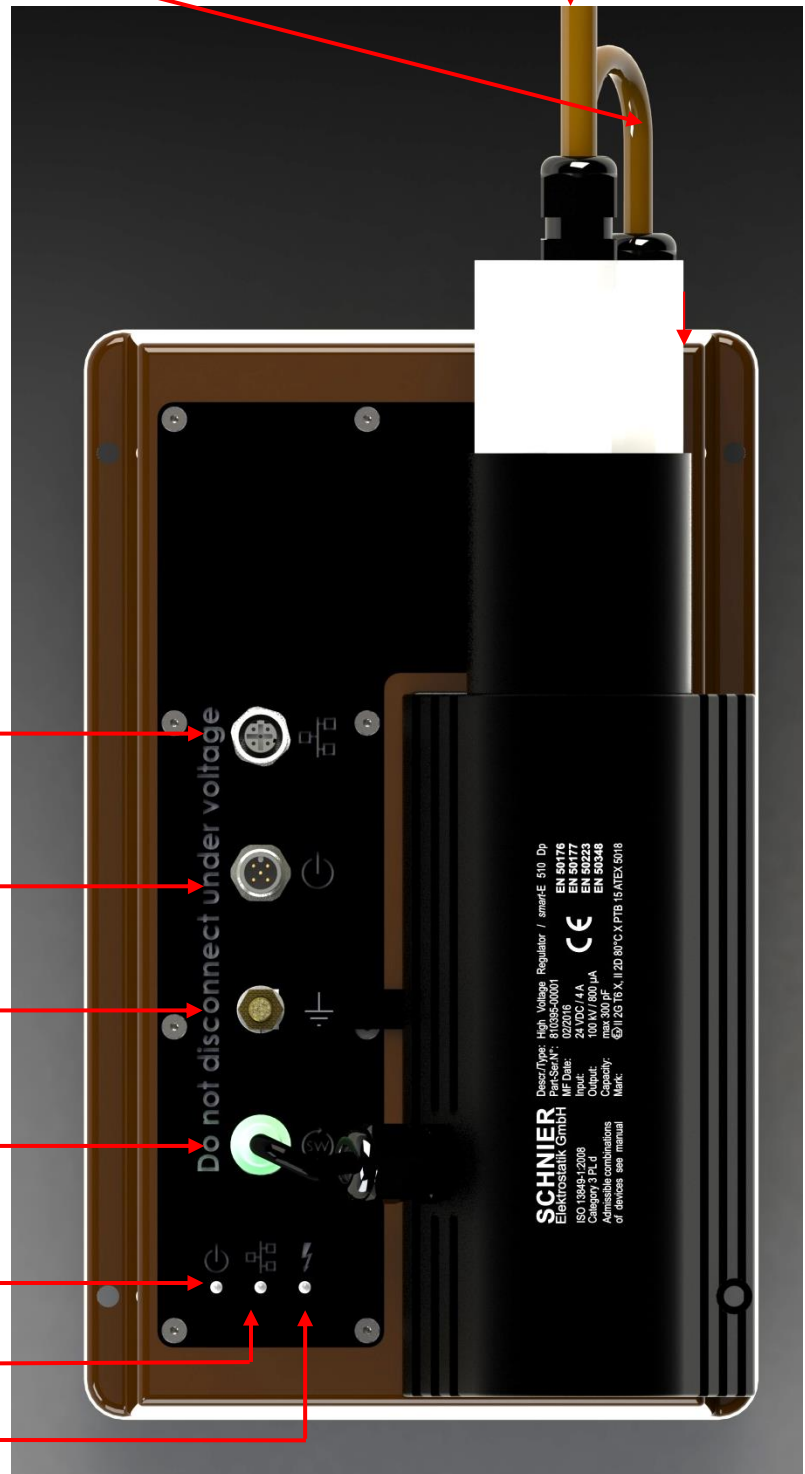

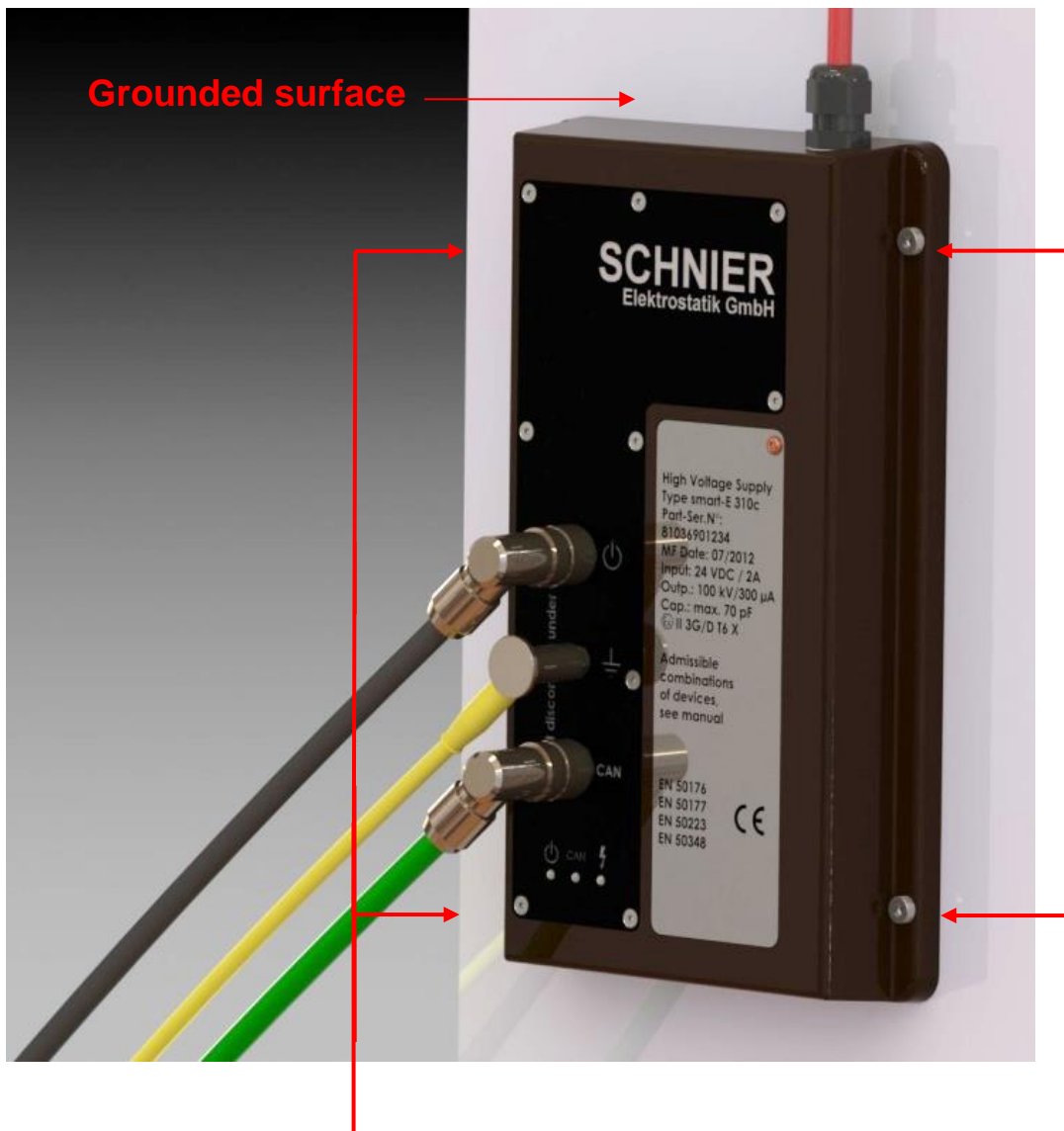

4.2. Mounting

4.2.1. HV-Supply without integrated discharger





4 screws M5 x 25 (16) – e.g. DIN 912
Value in brackets = smart-E 310
Value without brackets = smart-E 510

	<p>WARNING Overtightening of the screws can cause cracks.</p>
	<p>WARNING The HV generator must be installed without clearance on a grounded plate, to prevent electrostatic charging of the back.</p>
	<p>WARNING Do not disconnect connections under voltage.</p>

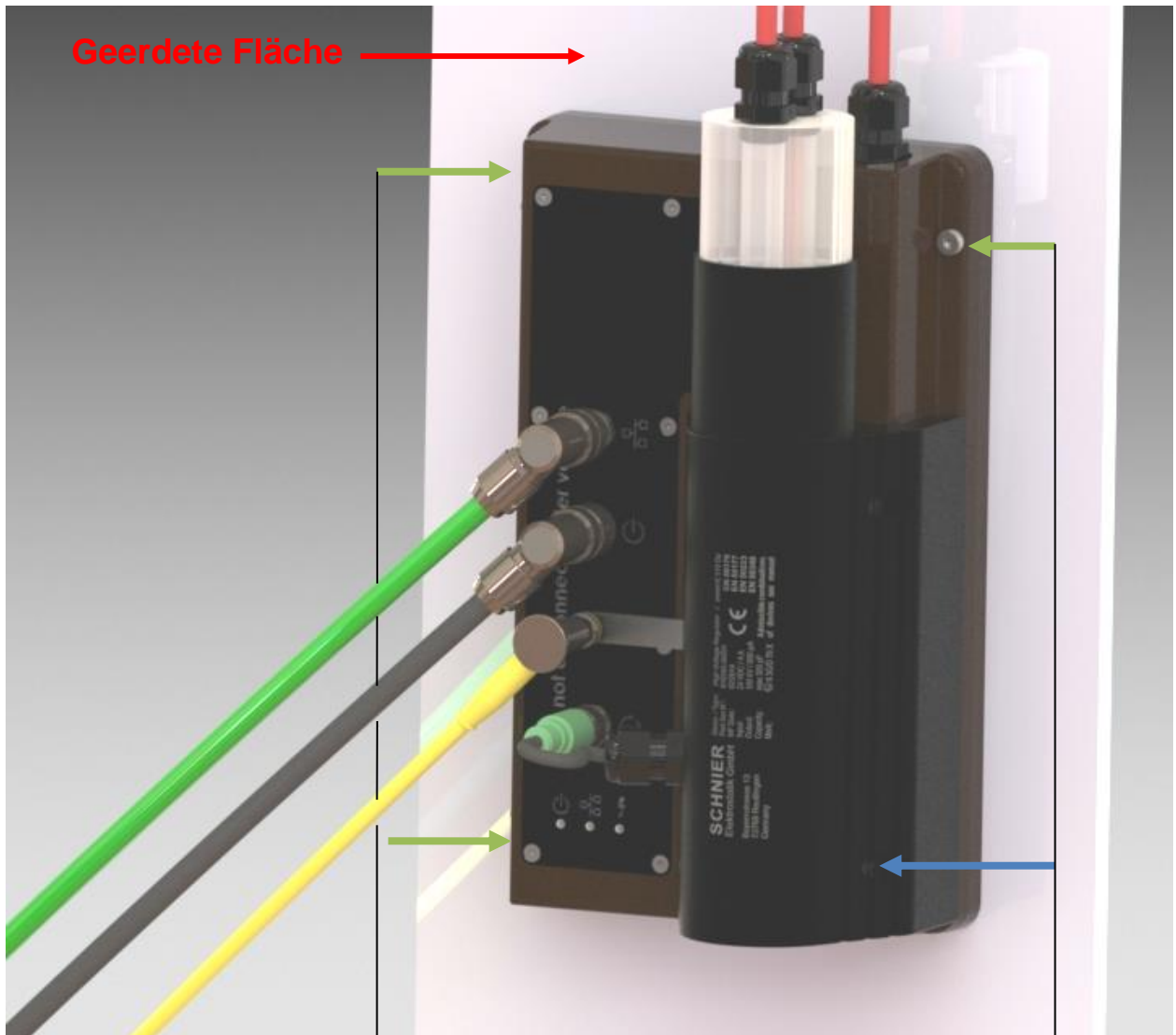
4.2.2. HV supply with integrated discharger



3 screws M5 x 25 (16) – z. B. DIN 912
 1 screw M5 x 35 (25) – z. B. DIN 912
 Value in brackets = smart-E 310Dx
 Value out of brackets = smart-E 510Dx

	<p>WARNING Overtightening of the screws can cause cracks.</p>
	<p>WARNING The HV generator must be installed without clearance on a grounded plate, to prevent electrostatic charging of the back.</p>
	<p>WARNING Do not disconnect connections under voltage.</p>

4.3. Dimensional drawings

4.3.1. HV-supply without integrated discharger

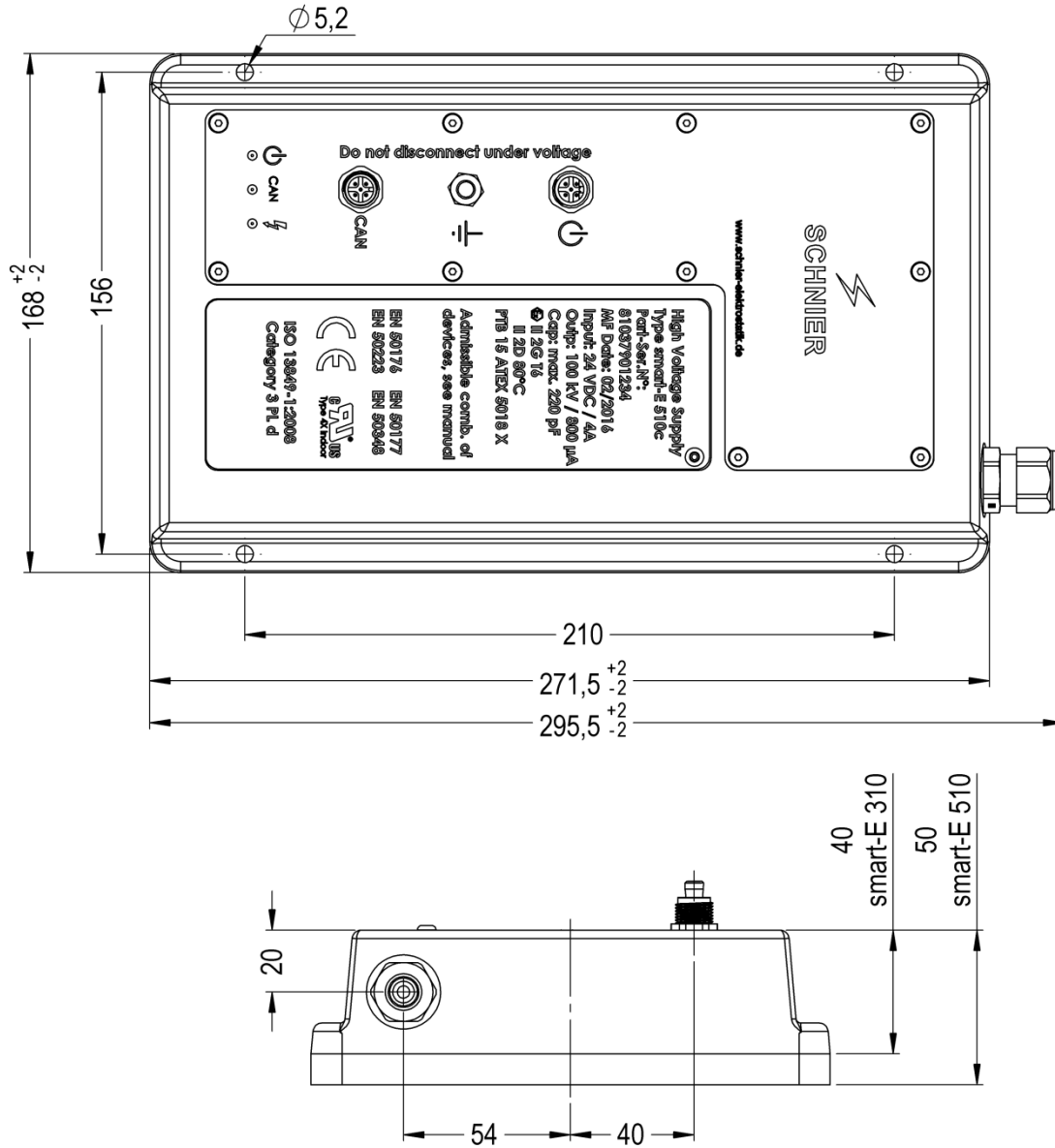

 SCHNIER has **3D-models and CAD files** available on the website www.schnier-elektrostatik.de

4.3.2. HV-supply with integrated discharger

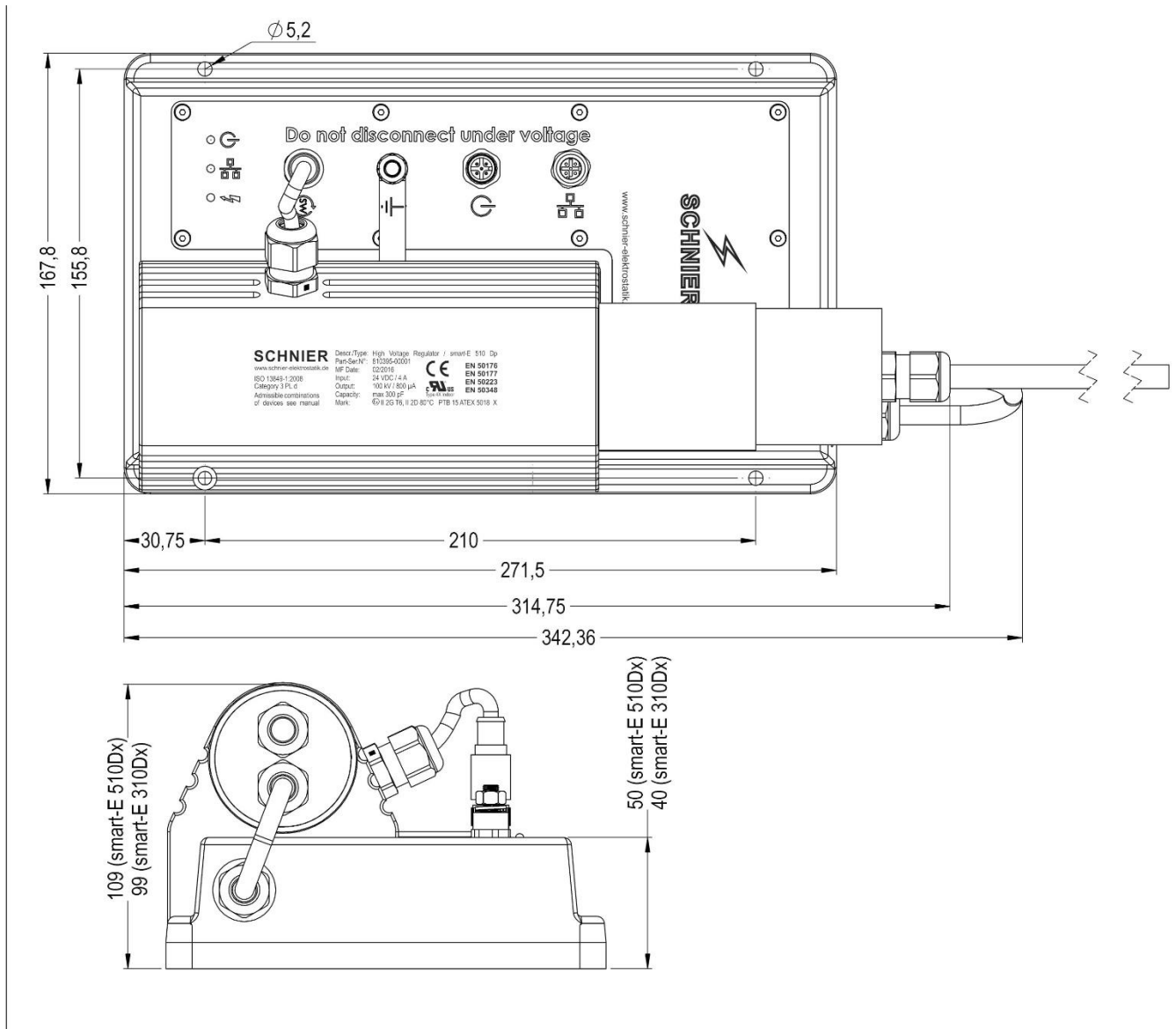



 SCHNIER has **3D-models and CAD files** available on the website www.schnier-elektrostatik.de



5. Electrical connection

	WARNING Do not open, plug-in or unplug connections under live voltage.
---	--

Following should be noted with the M12 connector:

	The connected cables have to be shielded. Operation is subjected to the circumstance of tightened M12 female screws.
	The counterpart has to fulfill the IP 64 standard.

	ATTENTION: If the bus interface is connected to wrong signals, the unit could be damaged. Under no circumstance connect the CAN-L/H to 24 V!
--	--

	24 V Drive and 24V CPU have to be fused with 4 A.
	The monitoring contact is construed for max. 24 V DC / 1A. For passing the performance level d it is mandatory that the conditions in Fehler! Verweisquelle konnte nicht gefunden werden. are fulfilled.

5.1. Feedback contact with performance level d

The feedback contact is built with a potential free, forcibly actuated relay. For the given performance level d the relay must not loaded with **24 V / 300 mA. Inductive loads are not permitted.** Also the load current influences the permissible switching frequency.

It is valid:

Load current feedback contact	Max cycles per year	Example given (ca.)
300 mA	350.000	60 Sec. Cycles at 365 days x 16 h
Current free (I < 20 mA)	500.000	60 Sec. Cycles at 350 days x 24 h

5.2. HS-Erzeuger mit CAN-BUS-Schnittstelle

(supplies with PROFINET, Ethernet/IP or EtherCAT see 5.3)

This picture shows the orientation of the M12 connectors on the front of the supply.

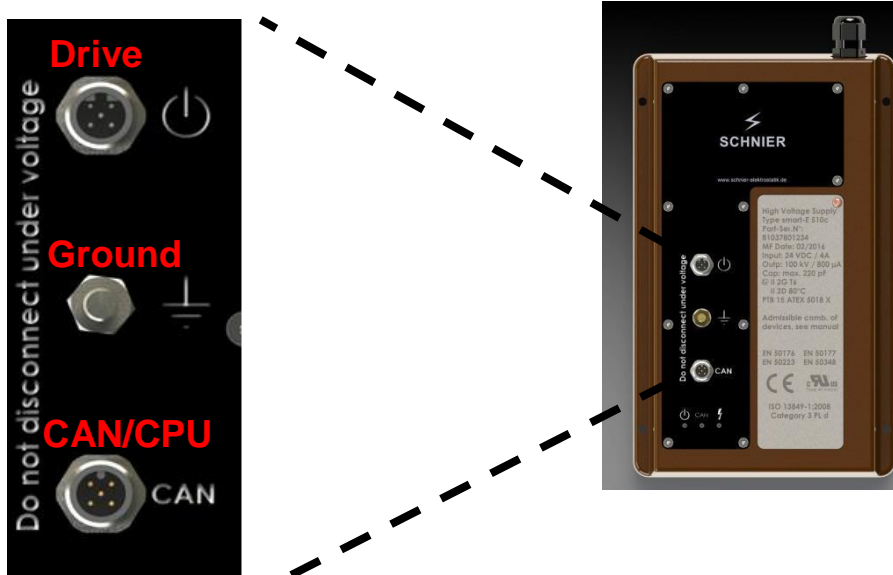

5.2.1. Bus interface



The CAN-Interface is a 5-pole A-coded plug. It contains CAN-bus wires and the 24 V power for the Controller (CPU).

	Pin	Signal	Symbol
	1	GND	CAN
	2	24 V CPU	
	3	GND	
	4	CAN-H	
	5	CAN-L	
	Screw	Shield	

5.2.2. Supply Connection

The supply connection is a 5-pin M12 B-coded plug. It carries the following signals:

- 1) Supply for the HV generator (24V-DRIVE)
- 2) Monitoring contact (relay closed, if the HV system is discharged)

	Pin	Signal	Symbol
	1	Monitoring contact	
	2	24 V CPU (do not use!)	
	3	GND	
	4	24V Drive	
	5	Monitoring contact	
	Screw	Shield	

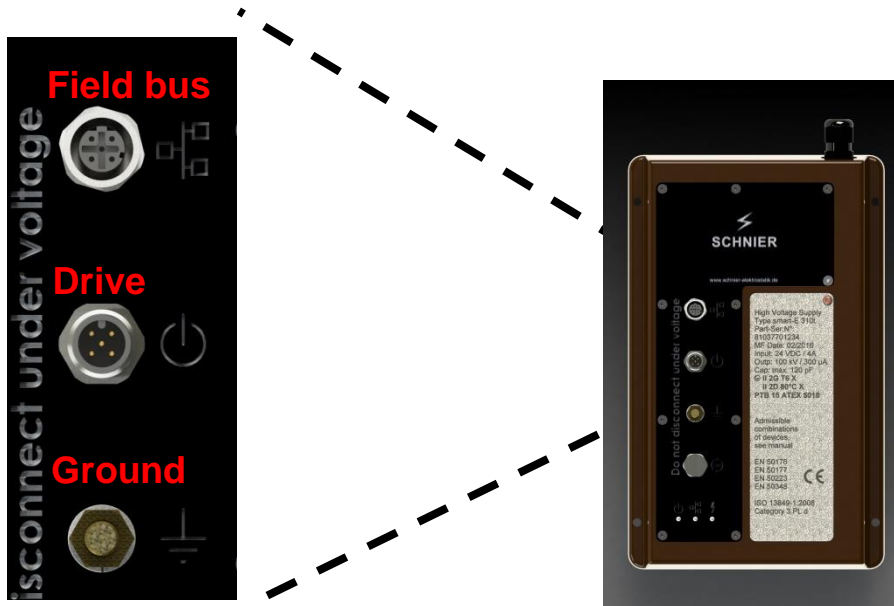

5.3. HV-supply with PROFINET, Ethernet-IP or EtherCAT-Interface (Supplies with CAN-Bus see 5.2)

Following picture shows the orientation of the M12 connectors on the front of the supply



5.3.1. Bus connection



The Ethernet connection is a 4-pin M12 D-coded socket:

	Pin	Signal	
	1	TXD+	
	2	RXD+	
	3	TXD-	
	4	RXD-	
	Screw	Shield	

5.3.2. Supply connection

The supply connection is a 5-pin M12 A-coded plug.
It carries the following signals:

- 1) Supply for the controller (24 V CPU)
- 2) Supply for the HV generator (24 V-DRIVE)
- 3) Monitoring contact (relay closed, if the HV system is discharged)

	Pin	Signal	
	1	Monitoring contact	
	2	24V CPU	
	3	GND	
	4	24V Drive	
		Monitoring contact	
	Screw	Shield	

5.4. Grounding

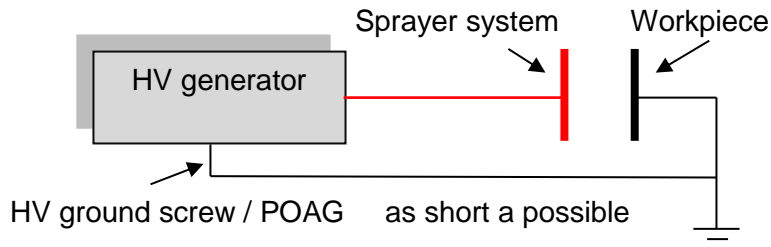

In the first step the ground is connected. The high-voltage circuit is closed between the HV generator and workpiece through the ground connection. The ground connection is a standard M6 threaded bolt.



	<p>WARNING</p> <p>The ground wire must be as short as possible and have a cross-section of at least 4 mm² (AWG 11). Do not lay cable parallel to current and bus lines.</p>
---	---

5.5.High Voltage Connection





In the second step the HV cable is attached.

	<p>The 4 mm pin of the HV cable must be completely pushed into the HV jack in the HV generator. The cable screw fitting must be properly tightened. Plug-in depth is 253 mm.</p>
	<p>CAUTION</p> <p>If shielded HV cables are used, the shielding must be removed and the cable grounded.</p>
	<p>CAUTION</p> <p>To prevent ozone and oxidation from occurring, we recommend greasing the connection.</p> <p>If high voltage cables with internal conductors made of plastic are used, <u>then the cable may not be greased.</u></p>



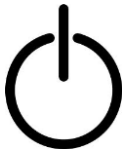





6. LED indicators





Please note, these LEDs are not safety components!

On the front side, 3 LEDs show continuous information about the current supply, network and the HV status. Each LED has two colors (red/green). 4 conditions can be displayed: off, green, red and yellow (red + green):

Status LED of the power supply		
		Dark: None of the 24V are on
		Green: Only 24 V CPU is on
		Yellow: 24V CPU and DRIVE are on
		Red: Only 24 V DRIVE is on

During operation, "yellow" must be displayed. **When accessing high voltage carrying parts, "green" or dark must be shown, at a minimum the 24V connection drive must be OFF.** "Red" should in normal operations, never be lit.

CAN oder 	CAN Bus		PROFINET, Ethernet/IP, Ether-CAT	
		Off: No bus signal available		Off: No bus connected
		Flashes: Pre-operational Single flash: Stopped Green: Operational		Green: Bus connected
		Green/yellow: Communication error		Green/yellow: Trial to create transfer
	Red: Bus off		Yellow: Übertragung hergestellt	

High voltage status		
		Green: HV off and discharged
		Yellow: HV switched off due to errors *
		Red: HV active on
		Dark: HV switched off and not yet discharged.

*Examples of errors are:

- I_{max} switch off
- U_{min} switch off
- Electrical arcing detected

For other shutdowns see descriptions of the status words.

After the corresponding status bit per field bus has been reset, the LED will either be dark or green depending on the residual energy.

7. Operation



Before operating, the following safety instructions must be read through carefully and must be understood:

7.1. Safety instructions for operation, service and repair

General information:

- A deviation from the conditions for the above mentioned intended use is not permitted.
- Furthermore the operating manual of the surrounding installation must be observed.
- The system must be operated by trained personnel.
- The employees must be informed at specific intervals about accident prevention regulations and operating instructions.
- During repair and service of the surrounding system the conditions for normal use of the HV generator apply.
- Never work on systems that are under high-voltage.



Specific instructions:

	The housing of the high-voltage generator is also used for cooling. Therefore the housing should be kept clean.
	Never operate the device if it is defective, damaged or opened.

Specific repair instructions:

If the generator **must be uninstalled for repair**, we recommend disconnecting the signals in the following sequence:

1. **Disconnect M12 CAN bus connection.**
2. **Disconnect M12 power supply connection.**
3. **Disconnect HV connection.**
4. **Disconnect ground connection.**

	WARNING Do not open, plug-in or unplug connections under live voltage.
	WARNING During the deinstallation of an HV generator, parts which are voltage carrying in operation must not be touched if they are not grounded with a grounding rod BEFORE the grounding connection of the HV generator is disconnected! This must especially be observed with defective HV generators!
	CAUTION The high-voltage should be switched off before disconnecting the 24V current wire. Exception: Emergency situations

The HV generator contains no parts to be repaired by the user. It can only be repaired by the manufacturer.

7.2. Generation of high voltage

The high voltage generator is controlled via the bus interface.

After switching on high voltage it moves into a programmable start up ramp to the target value U or until target value I is reached.

The actual voltage and current values can be read out from the bus system.

For a detailed description of all parameters, results and status information, see the following section "Field-Bus interface specification".

7.3. Switching on high voltage

When switching on high voltage the power supply of the HV generator (24 V DRIVE) must be on. Switch on is then done via the bus system

7.4. Switching off high voltage

The high voltage can be switched off at any time via the bus system.

	<p>WARNING</p> <p>To release access to high voltage carrying parts, additionally:</p> <ul style="list-style-type: none">• The power supply of the HV generator (24V DRIVE) must be safely disconnected and secured against switching back on.• Monitoring contact of the HV generator must be closed.• The specifications for secure access to the spray zone listed in Section 3 must be fulfilled.
---	---

7.5. Voltage and current control

The smart-E 310 or 510 has voltage and current control. These can be set using the following parameters:

- a) U target
Target value for high voltage 10-100 kV
- b) I Limit
Target value for current limiting 10-300 μ A
(only active if I Limit is set below I max)
- c) I max
Target value for the overcurrent switch off threshold 10-300 μ A
(also active, if I Limit is set lower than I max, however only for a very fast current change such as during an electrical arc)
- d) U min
Target value for the switch off threshold minimum voltage. 10-100 kV
(Safety shutdown if current limiting is active)

7.5.1. Constant voltage operation

Closed control circuit system with direct feedback of the actual value of the high voltage output. In constant voltage mode, the set output voltage is held constant by a control device, independent of variable operating currents up to the performance limit of the high voltage device.

NOTE this operating mode is typically labeled with U_k .

To work in this operating mode the target value I_{Limit} must be set higher than the target value I_{max} .

	<p>The switch off threshold $I_{\bar{u}}$ must take local and operational conditions into consideration, then be determined and documented.</p>
	<p>In the case of a non-permitted increase in operating current I_b check that high voltage is shut down when the threshold value $I_{\bar{u}}$ is reached.</p>
	<p>During first inspection check the determined threshold value $I_{\bar{u}}$.</p>
	<p>It is not permitted to have a threshold value $I_{\bar{u}}$, where hazardous discharges or electrical arc between high voltage leading and grounded parts of the system can be calculated on, if the permitted safety distance is not achieved.</p>

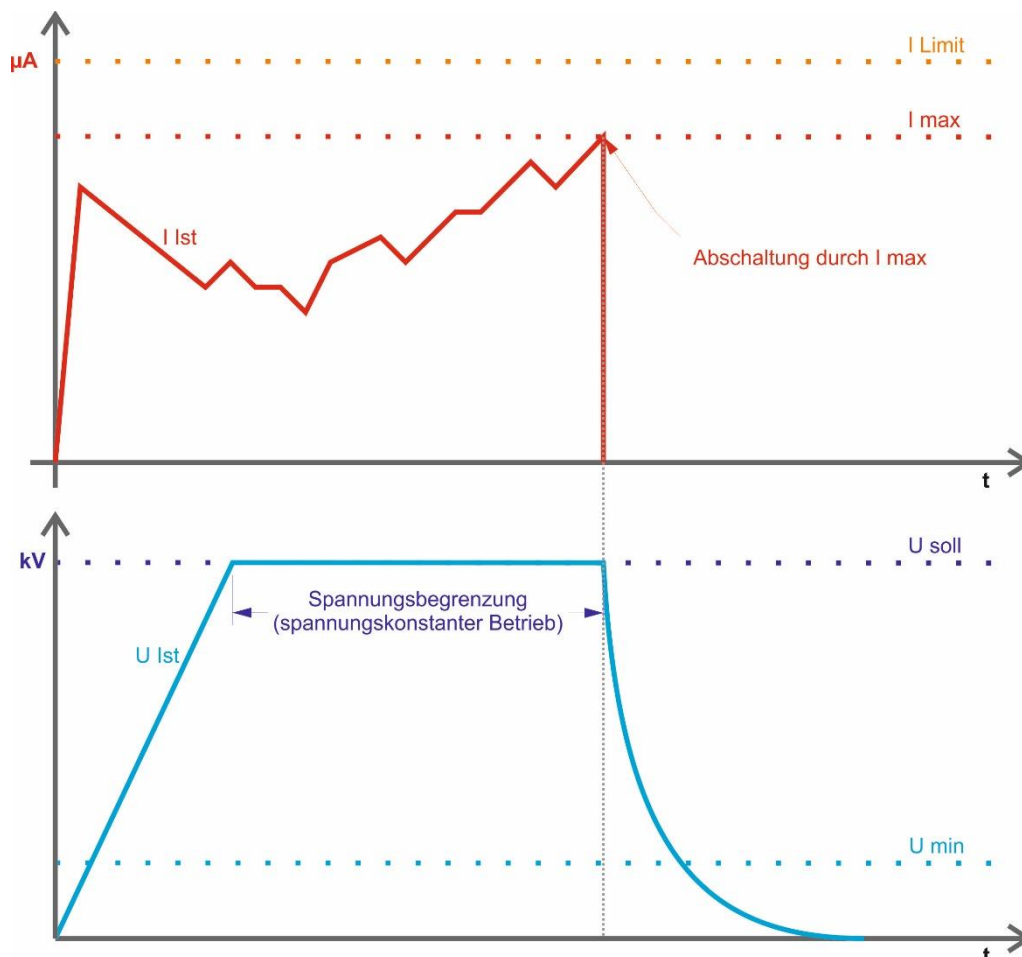

7.5.2. Constant current operation

Closed control circuit system with direct feedback of the actual value of the high voltage current to a control device. Operating current is thereby held constant, the high voltage output varies the load dependency between a minimum and maximum process defined value.

NOTE this operating mode is typically labeled with I_k .

To work in this operating mode the target value I_{Limit} must be set lower than the target value I_{max} .

	<p>In constant current operating mode, check for safe switch off of the high voltage supply.</p>
	<p>The switch off threshold U_{min} must take local and operational conditions into consideration, then be determined and documented.</p>
	<p>Check that high voltage is switched off if an unauthorized drop in voltage causes it to go below the switch off threshold value U_{min}.</p>
	<p>During first inspection check the determined threshold value $I_{ü}$.</p>
	<p>It is not permitted to have a threshold value U_{min}, where hazardous discharges or electrical arc between high voltage leading and grounded parts of the system can be calculated on, if the permitted safety distance is not achieved.</p>

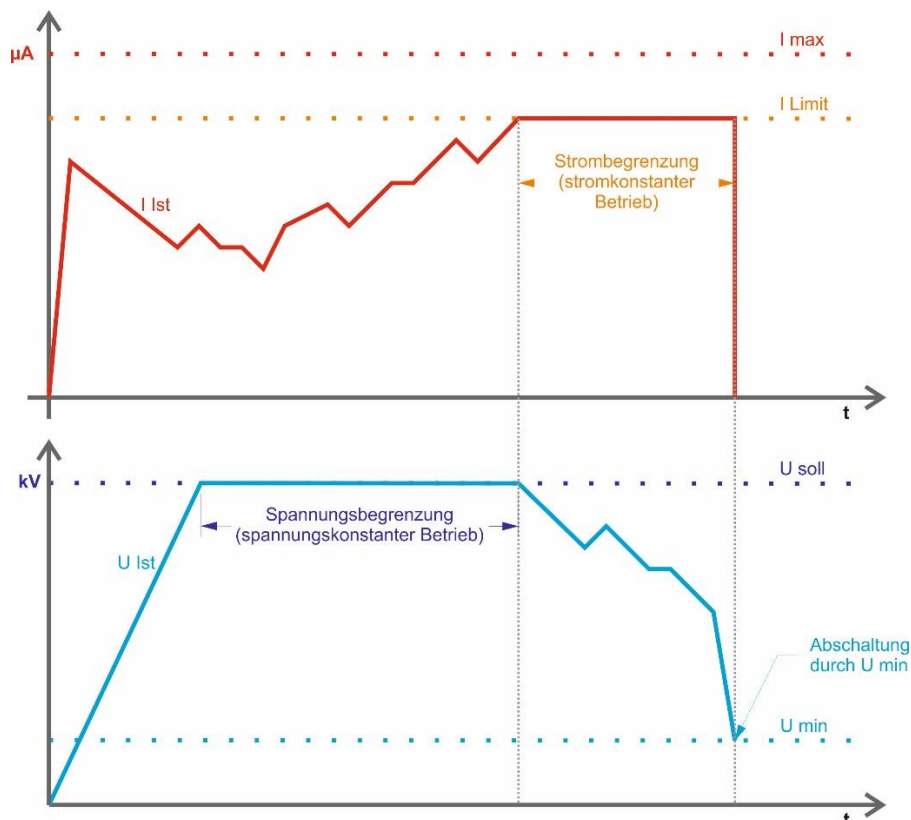

7.6. Dynamic switch off di/dt

Dynamic switch off di/dt is known extensively from older high voltage systems which trigger for a fast increase in current and switches off high voltage. This is used to detect a high voltage electrical arc. Especially in modern, dynamic processes, e.g, robotic painting, this switch off leads to undesired shutdown and therefore standstill times which, in practice, often means the di/dt function is deactivated and an important safety feature is switched off. For the smart-E310 or 510 the di/dt switch off is replaced by a significantly improved electrical arc detection.

7.7. Electrical arc detection

Electrical arc detection for the smart-E 310 or 510 is in a position to detect high voltage electrical arcs without undesired switch off during dynamic processes such as robot painting. The sensitivity can be set in 9 levels from 1 to 10. The highest sensitivity is at level 1, accordingly the most insensitive level is 10. For 0, electrical arc detection is deactivated.

7.8. Monitoring residual energy

7.8.1. Functional description

Once the HV generator is switched off, high voltage carrying parts of a system are still energized due to their electrical capacity.

Before accessing the cabin, all high voltage carrying parts as described in the "Safety instructions for operation, service and repair" section describes a safe value below which discharge is done. This signals the residual energy monitoring system (monitoring contact HV generator): as soon as the high voltage has been safely discharged, the integrated relay closes the monitoring contact:

Relay contact	Condition	Meaning
Closed	HV is switched off AND High voltage is discharged* AND Generator self-test is OK	From the high voltage standpoint, the system is safe to access
Open	All other conditions	Access must be interlocked

* The safety threshold is permanently fixed, independently of the system configuration. The value must be determined and verified scientifically.

Note: 24 V CPU must be applied to operate the relay. Switching off the 24 V DRIVE however, is not checked, before the relay closes.





The residual energy monitoring is a safety function. In compliance with the specifications in this operating manual, the new editions of the smart-E devices have Performance Level:

ISO 13849-1:2008 Category 3 PLd

These devices have PL d details on the label of the model plate. Older devices without this information do not have Performance Level d.

7.8.2. Safety relevant details

The installed residual energy monitoring of the HV generators of the smart-E series is designed redundant and 1-error safe. To maintain this advantage also in interactions with the surrounding system, the following measures are absolutely required by the user:

	Measures	Reason
	All safety relevant feedback for residual energy in the system may only be used by the relay contact.	The used fieldbus is considered as unsecure.
	Superordinate controls must be checked for each high voltage start up to ensure that the monitoring contact signals as "open".	The feedback relay signals back via the monitoring contacts, whether the voltage at the output of the HV generator has discharged to a non-dangerous value (i.e. "safe" in the sense of product standards). This is an open normally-open contact. Thus open means "dangerous". This prevents short-circuits in the supply cable or wire errors that can be confused with a "closed" condition.
	It must check switch off of the supply voltage (24 V DRIVE) cyclically using the set DRIVE power status bits of the HV generator.	To detect and exclude wiring errors of the 24 V supply (e.g. DRIVE and CPU) or short circuits between both, so the DRIVE is still supplied.
	All high voltage carrying parts must be permanently and conductively connected using the high voltage outputs of the HV generators. A maximum of 10 MOhms is permitted (measured with max. 500 VDC).	Market observations have shown that especially in robot use no 2 HV cable is laid redundant. The HV connection from the HV generator to the spray system is with one channel. A defective or improperly plugged in HV cable can lead to false residual energy measurements and falsely closed relay contact.*
	For a defective HV generator, all high voltage carrying parts must be grounded before touching (e.g. using a grounding pole).	General safety measures for defective devices.

*) For expanded systems, we recommend the user to absolutely install another separate residual monitor at another location, in order to achieve the 1-error safety for the entire system.

7.9. Operating Mode of the integrated discharger

Without additional measures, as for example the use of a ground switch or discharger, the electrostatic system is discharged via the measurement/bleeder resistance of the HV generator. This is done after an E function.

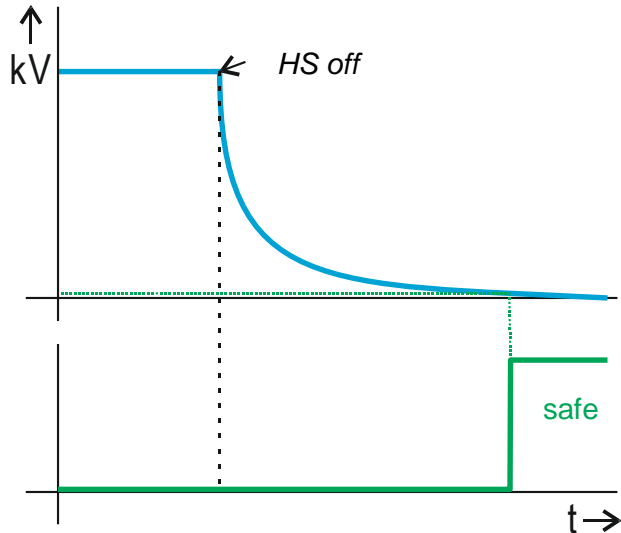

This means that the discharge process is fast at the beginning, however becomes proportionally slower. The smart-E 310 and smart-E 510 signal messages "safe" if the output voltage $< 500\text{ V}$, since only this value is considered "safe". This means concretely that the discharge time often takes longer than 10 seconds.

If this discharge time is not available, because for example a Bell-cleaner is being used, then the discharger can reduce the discharge time to a minimum.

The discharger must not be separately controlled; this is done by the smart-E 310 or smart-E 510. As soon as the high-voltage is switched off, the smart-E 310 or smart-E 510 activates the discharger. This then draws a constant discharge current of $200\text{ }\mu\text{A}$ until the system is completely discharged.

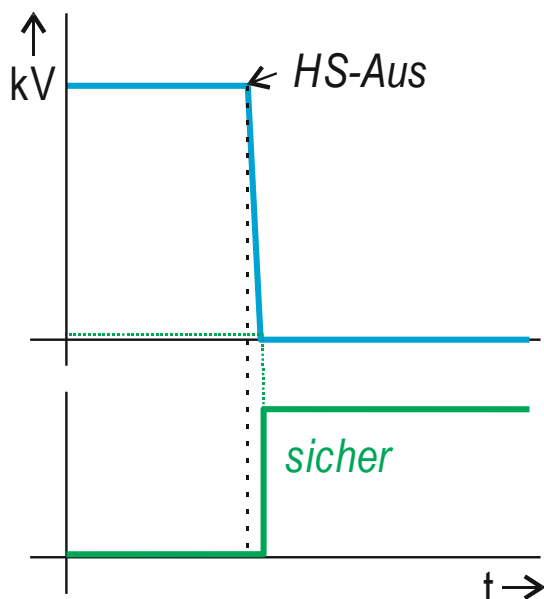

With a system capacity of 2 nF and an output voltage of 100 kV , the high-voltage is discharged within a second.

Specification of the fieldbus interfaces

Chapter 8 describes the CAN-Bus interface

Chapter 9 describes the PROFINET interface

Chapter 9 describes the Ethernet/IP interface

Chapter 10: describes the EtherCAT interface

8. Specification of the CAN-bus-interface

8.1. Bus interface

The smart-E high voltage generator is a CAN slave and to be factory provided with Node ID 2 and set to a baud rate of 250 kBit/s. 50 kBit/s and 125 kBit/s can also be set. Node ID and baud rate are set via co-called SDOs (see below) and always assumed after a restart. All other parameters are immediately assumed.

	<p>CAN bus system always requires a connection resistance. This is not integrated into the HV generator.</p>
---	--

8.2. Application interface

8.2.1. EDS-Files

	<p>Use our standardized "EDS" files to load the applications interface to your control software.</p> <p>EDS files are simple text files that use network configuration tools to support the identification of products and their simple equipping in a network.</p> <p>SCHNIER provides an EDS file with all parameters and format information of the HV generator. It can be obtained on the smart-E website www.smart-E310.de.</p>
---	---

8.2.2. Control of the generator via CAN open

This generator uses the CAN open protocol for communication. After the 24 V CPU supply has been applied, the recording processor starts and sends a boot up message.

The generator is now controlled via the receive-PDO "RXPD1" with the COB ID "0x200+Node-ID".

Status information and measurements are saved by the generator in send-PDO "TXPDO1 with the COB ID "0x180+Node-ID". These must then be requested by the superordinate controls using SYN objects.

Other parameters are transferred via SDOs. Details are described in the object directory.

8.2.3. Structure and content of the PDOs

RXPDO1 contains 3 objects from the object directory and is set up as follows:

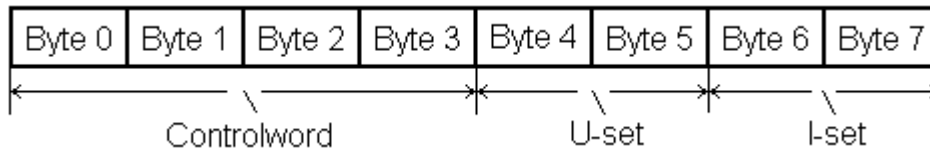

The objects are permanently preset.

TXPDO1 also contains 3 objects from the object directory and is set up as follows:

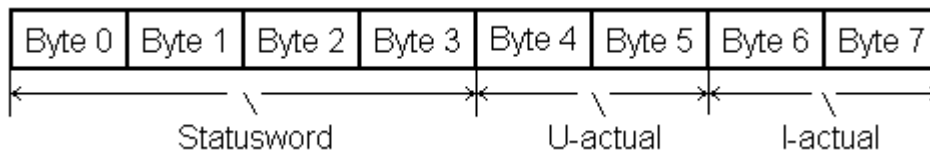

The objects are permanently preset.

8.2.4. An example of the controls of the PDOs

If there are no error messages or switch offs and 24V drive is available then for example, with the following RXPDO1 the generator can be switched on to 70 kV output voltage with an I-Limit of 100 uA.

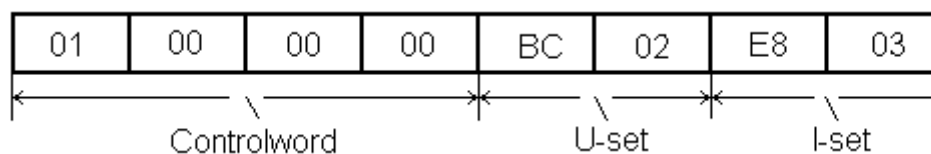

The set values must be in the permitted parameter area, otherwise the command is not accepted and "Invalid parameter" is output.

In the case of a switch off (e.g. electrical arc or U_{min} or for a warning, the generator sets the corresponding Bit in the status register and the collective Bit.

The status of the generator can be read out via TXPDO1 where an SYN object is sent. The following example shows the content of a TXPDO1 after an I_{max} switch off:

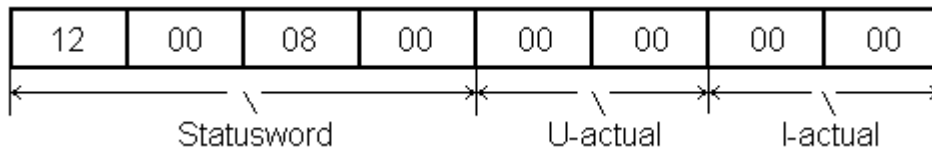

Current and voltage at the output return to 0, depending on the system capacity.

To switch on the generator again, the control bit HV-ON must be reset and the error and switch off acknowledged. This is done, for example, with the following RXPDO1:

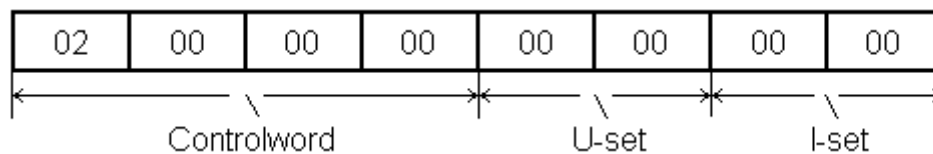

If all errors are acknowledged, the high voltage is switched off and fades, then the "High voltage is safely off" Bit is set. (Note: this Bit does not have a safety function!).

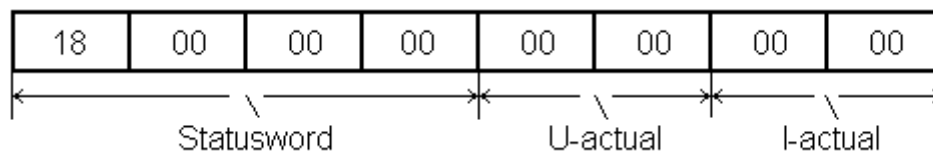

If high voltage is switched off, however the output voltage has not faded, then the TXPDO1 looks as follows:

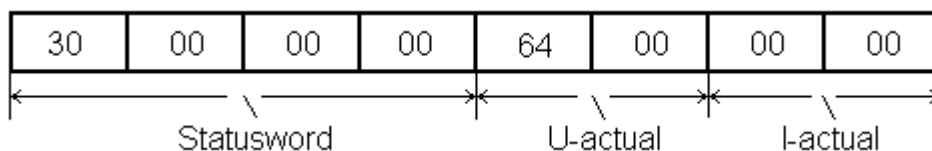

The present voltage remains at 10 kV, however current is no longer flowing. The system then still contains energy, although the generator is switched off.

8.2.5. Object directory

Index	Subindex	Datatype	Length	Parameter	Unit	Access	Accessstype	Min	Default	Max	Comment
Geräteinformationen											
0x2000	-	UNSIGNED8	8 Bit	CANopen Node ID	-	RW	SDO	1	2	127	take effect after reset
0x2001	-	UNSIGNED8	8 Bit	Baudrate (50, 125, 250)	kbit/s	RW	SDO	50	250	250	take effect after reset
0x2002	-	UNSIGNED32	32 Bit	Firmware-Version	-	R	SDO	0.0.1	-	255.255.255	
Prozessdaten											
0x2010	-	UNSIGNED32	32 Bit	Controlword	-	RW	PDO				
0x2011	-	UNSIGNED32	32 Bit	Statusword	-	R	PDO				
0x2012	-	UNSIGNED16	16 Bit	Voltage set value	100 V	RW	PDO	100	-	1000	Value out of the valid range will be ignored. A warning will be set.
0x2013	-	UNSIGNED16	16 Bit	Current set value	0,1 µA	RW	PDO	0	-	6000/8000	Value out of the valid range will be ignored. A warning will be set. 8000 below 80 kV (SW V3.0+)
0x2014	-	UNSIGNED16	16 Bit	Voltage actual value	100 V	R	PDO	0	-	1240	
0x2015	-	UNSIGNED16	16 Bit	Current actual value	0,1 µA	R	PDO	0	-	11330	
Parameter											
0x2020	-	UNSIGNED16	16 Bit	Reserve							
0x2021	-	UNSIGNED16	16 Bit	Threshold of Umin-switchhoff	100V	RW	SDO	0	150	1000	
0x2022	-	UNSIGNED16	16 Bit	Reserve							
0x2023	-	UNSIGNED16	16 Bit	Threshold of Imax-switchhoff	0.1µA	RW	SDO	1	6000	8000	5500 below SW V3.0
0x2024	-	UNSIGNED16	16 Bit	Sensitivity of sparkover detection	-	RW	SDO	0	5	10	the smaller is the value, the more sensitive is the detection. 0: disable
0x2025	-	UNSIGNED16	16 Bit	Reserve							
0x2026	-	UNSIGNED16	16 Bit	Voltage ramp up	kV/s	RW	SDO	1	10	100	

8.2.6. Bit map

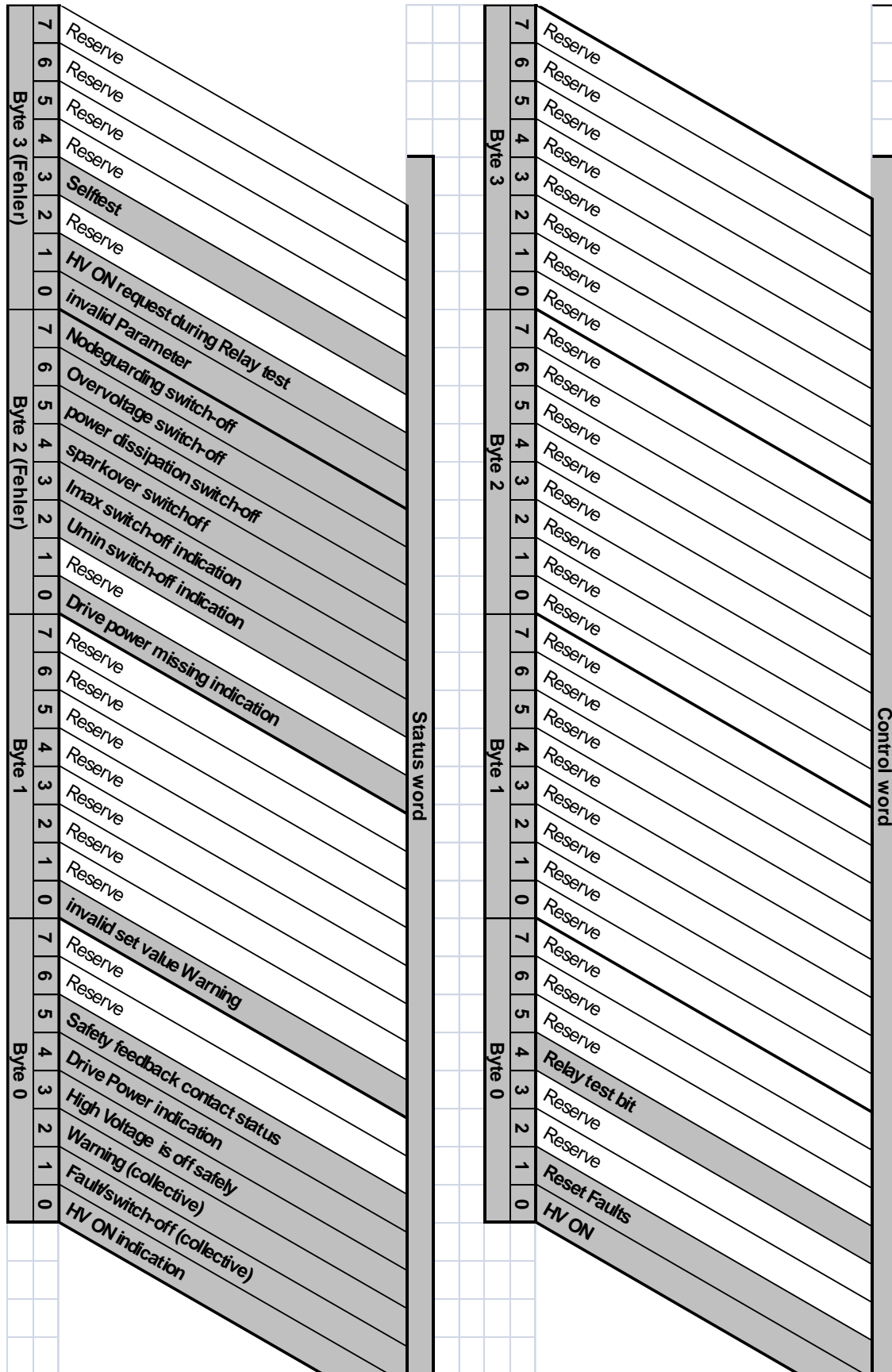

8.2.7. Describing the control word

Byte	Bit	Control bit	Description
0	0	High voltage ON	1: Switch on high voltage 0: Switch off high voltage
	1	Reset error	1: All errors are confirmed 0: No action Note: In order to switch on HV again, after an error has been confirmed, the "HV ON" bit must be reset/set.
	2	Reserve	
	3	Reserve	
	4	Relay test bit	1: Open the safety relay 0: No action / close relay Note: The safety relay is controlled by the HV generator depending on the remaining voltage on the HV connection. If the contact is found in the "safe" position (closed), it can be opened with this Bit for test purposes. Note: When the relay test bit is set, the HV cannot be switched on.
	5..7	Reserve	
1..3	0..7	Reserve	

8.2.8. Description of the status word

Byte	Bit	Status bit	Description
0	0	HV display ON	1: HV creation is switched on 0: HV creation is switched off
	1	Collective error / switch off	1: For error or switch off 0: No error
	2	Collective warning	1: For warning 0: No warning
	3	The high voltage is safety off. CAUTION: This SW bit does not fulfill the Performance Level, this is only achieved by HW feedback.	1: If the high voltage has been switched off and the output voltage has discharged to a safe level. 0: If the high voltage is switched on / or the output voltage has not been discharged to a safe level 0: If a self-test error of the device has been detected
	4	Drive power status	1: 24 V DRIVE is on 0: 24 V DRIVE is not on
	5	Monitoring contact status	1: Relay contact open 0: Relay contact closed
	6..7	Reserve	

1	0	Warning: invalid target value for voltage or current	1: An invalid parameter (value outside of range) has been received 0: Parameter valid
	1..7	Reserve	
2	0	Missing DRIVE power (when HV on)	1: 24 V DRIVE is not on and HV ON has been set 0: No error or error acknowledged
	1	Reserve	
	2	U _{min} switch off	1: Umin switch off 0: No error or error acknowledged
	3	I _{max} switch off	1: Imax switch off 0: No error or error acknowledged
	4	Electrical arc switch off	1: Electrical arc detected and switched off 0: No error or error acknowledged
	5	Power loss too high	1: Output power too low in relationship to the input power 0: No error or error acknowledged
	6	Over-voltage switch off	1: An actual value above 109 kV has been detected 0: No error or error acknowledged
	7	Node guarding error switch off	1: Switch off after loss of node guarding signal 0: No error or error acknowledged
3	0	Warning invalid parameters	1: An invalid parameter (value outside of range) has been received in the object directory 0: Parameter valid
	1	HV ON specification during relay test	1: HV ON was set during activated relay test (HV remains off) 0: No error or error acknowledged
	2	Reserve	
	3	Self-test	1: Self-test of the smart-E malfunction (program check sum, internal hardware, current measurement*) 0: No error or error acknowledged
	4..7	Reserve	

* The check of the current measurement occurs when switching on the device (24 V CPU on), also for each high voltage switch off.

9. PROFINET interface specifications

(smart-E 310p, smart-E510p, smart-E 310Dp, smart-E 510Dp)

9.1. Bus interface

Profinet based on the ethernet physical layer. To create communication between the smart-E 310 or smart-E 510 and profinet controller (PN controller), no special steps are required. The IP address is set automatically. See the manual of your PN controller for further information. **For examples of setting up communications, see our smart-E website www.smart-E310.de.**

9.2. Application interface

9.2.1. GSD-Files

i	<p>Use our standardized "GSD" files to load the applications interface to your control software.</p> <p>GSD files are simple text files that use network configuration tools to support the identification of products and their simple direction in a network.</p> <p>SCHNIER provides a GSD file with all parameters and format information of the HV generator. It can be obtained on the smart-E website www.smart-E310.de.</p>
----------	--

9.2.2. Write the data sets (record writes)

The user interface uses datasets (records) for two parameter settings of the HV generator:

Byte	Parameters	Unit	Min	Standard	max	Remarks
0	kV ramp	kV/s	1	20	100	Speed when starting up voltage
1	Sensitivity of electrical arc detection	-	0	5	10	0: Electrical arc detection off 1~10: Highest to lowest sensitivity.
As usual this parameter could be unchanged. Do not switch off electrical arc detection in normal operation!						
2..15	Reserve					

9.2.3. Receive I/O data mapping (PN-IO controller to PN-IO device)

Byte 0	Byte 1	Byte 2	Byte 3	Byte 4	Byte 5	Byte 6	Byte 7	Byte 8	Byte 9
Control word		U target value (kV)		U min (kV)		I Limit (uA)		Imax (uA)	

Byte 10~19
Reserve

9.2.4. I/O data mapping transfer: (PN-IO device to PN-IO controller)

Byte 0	Byte 1	Byte 2	Byte 3	Byte 4	Byte 5	Byte 6	Byte 7	Byte 8	Byte 9
Status word				Service code		U actual (kV)		I actual (uA)	

Byte 10~15	Byte 16	Byte 17	Byte 18	Byte 19
Reserve	SW Subversion	SW Version	HW Version	Reserve

9.2.5. I/O data definition (area, unit, standard)

Data	Unit	Minimum	Maximum	Standard	Remarks
U target	kV	10	100	0	kV target value/limiting value
U min	kV	10	100	0	Limit value for Umin-switch off
I Limit*	uA	10	800 / 600	0	Target value for current limiting value (800 below 80 kV)
I max.*	uA	10	800	0	Limit value for Imax - switch off
U actual	100 V	0	1240	-	Actual value kV
I actual	uA	0	1130	-	Actual current

*: Valid from SW version 3.0, prior to that: 550 uA

Values outside of these areas (min, max) are ignored. The warning "invalid parameters" is output.

Caution: The Byte sequence is Little-Endian. The Byte sequence can be taken from the following examples:

Example: From a smart-E 510 received data:

Control word		U Target value		U min		I Limit		Imax	
HV ON		20 kV		5 kV		256 uA		50 uA	
Byte 0	Byte 1	Byte 2	Byte 3	Byte 4	Byte 5	Byte 6	Byte 7	Byte 8	Byte 9
0x01	0x00	0x14	0x00	0x05	0x00	0x00	0x01	0x32	0x00

Example: From a smart-E 510 sent data:

Byte 0	Byte 1	Byte 2	Byte 3	Byte 4	Byte 5	Byte 6	Byte 7	Byte 8	Byte 9
0xC0	0x00	0x00	0x00	0x00	0x00	0xC8	00	0x0A	0x00
Status word				Service code		U actual		I actual	
						20 kV		10 uA	

9.2.6. Describing the control word

Byte	Bit	Control bit	Description
0	0	High voltage ON	1: Switch on high voltage 0: Switch off high voltage
	1	Reset error	1: All errors are confirmed 0: No action Note: In order to switch on HV again, after an error has been confirmed, the "HV ON" bit must be reset/set.
	2	Reserve	
	3	Reserve	
	4	Heartbeat	The <i>smart-E</i> expects a heartbeat signal (1Hz) via the PROFINET. This monitoring is initially deactivated and is then activated with the first heartbeat. If a heartbeat never comes then the HV generator can be operated without it. As soon as the heartbeat comes once, this is monitored and if it remains off the generator shows an error.
	5	Reserve	
	6	Reserve	
	7	Relay test bit	1: Open the safety relay 0: No action / close relay Note: The safety relay is controlled by the HV generator depending on the remaining voltage on the HV connection. If the contact is found in the "safe" position (closed), it can be opened with this Bit for test purposes. Note: When the relay test bit is set, the HV cannot be switched on.
1	0...7	Reserve	

9.2.7. Description of the status word

Byte	Bit	Status bit	Description
0	0	HV display ON	Mirror bit of the HV EIN bit (V2.01 and higher)
	1	Reserve	
	2	Collective error / switch off	1: For error or switch off 0: No error
	3	Collective warning	1: For warning 0: No warning
	4	The high voltage is safety off. CAUTION: This SW bit does not fulfill the Performance Level, this is only achieved by HW feedback.	1: If the high voltage has been switched off and the output voltage has discharged to a safe level 0: If the high voltage is switched on / or the output voltage has not been discharged to a safe level 0: If a self-test error of the device has been detected
	5	Reserve	
	6	Drive power status	1: 24 V DRIVE is on 0: 24 V DRIVE is not on
	7	Monitoring contact status	1: Relay contact open 0: Relay contact closed
1	0	Heartbeat	This Bit is switched every second between 1 (logic high) and 0 (logic low) to display that the HV-supply is still active.
	1	Reserve	
	2	Reserve	
	3	Reserve	
	4	Warning: invalid parameters	1: An invalid parameter (value outside of range) has been received 0: Parameter valid
	5	I _{max} warning	1: I actual is above 80 % of I _{max} 0: I actual is below 80 % of I _{max}
	6	Reserve	
	7	Reserve	

2	0	I _{max} switch off	1: I _{max} switch off 0: No error or error acknowledged
	1	U _{min} switch off	1: U _{min} switch off 0: No error or error acknowledged
	2	Electrical arc switch off	1: Electrical arc detected and switched off 0: No error or error acknowledged
	3	Over-voltage switch off	1: An actual value above 109 kV has been detected 0: No error or error acknowledged
	4	Communication error display	1: Heartbeat disappeared 0: no error or error acknowledged
	5	Missing DRIVE power (when HV on)	1: 24V DRIVE is not on and HV ON has been set 0: No error or error acknowledged
	6	HV ON specification during relay test	1: HV ON was set during activated relay test (HV remains off). 0: No error or error acknowledged (V2.01 and higher)
	7	Power loss too high	1: Output power too low in relationship to the input power 0: No error or error acknowledged
3	0	Reserve	
	1	Reserve	
	2	Reserve	
	3	Reserve	
	4	Reserve	
	5	Reserve	
	6	Reserve	
	7	Self-test	1: Self-test of the HV-supply malfunction (program check sum, internal hardware, current measurement*) 0: No error or error acknowledged

* The check of the current measurement occurs when switching on the device (24V CPU on), also for each high voltage switch off.

10. Specification of the Ethernet/IP interface

(smart-E 310e, smart-E510e, smart-E 310De, smart-E 510De)

10.1. Bus interface

Ethernet/IP based on the ethernet physical layer. To create communication between the smart-E510 (EIP adaptor) and the Ethernet/IP controller (EIP scanner), the corresponding settings must be adjusted in the controller (see manual of your Ethernet/IP controller for further information):

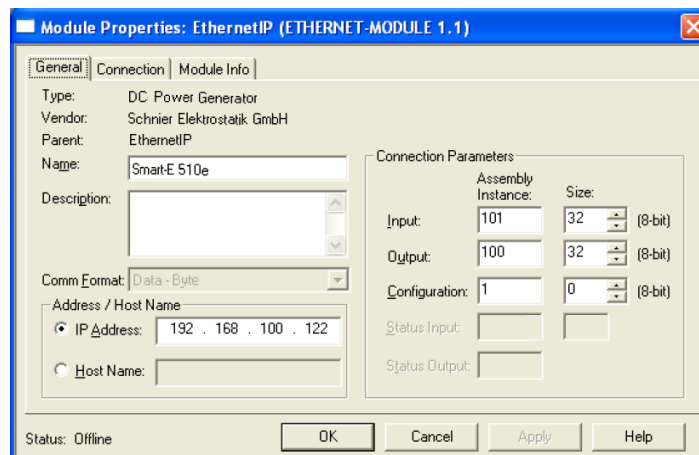

The HV generator has a factory preset IP address 192.168.100.122. This can be changed via the integrated webserver at <http://IP-Adresse/ipconfig>.

	<p>CAUTION</p> <p>Changes should only be made here if you are knowledgeable in working with network settings. If the settings no (longer) correspond to your network and the connection can no longer be made, the device must be returned to the manufacturer!</p>
---	---

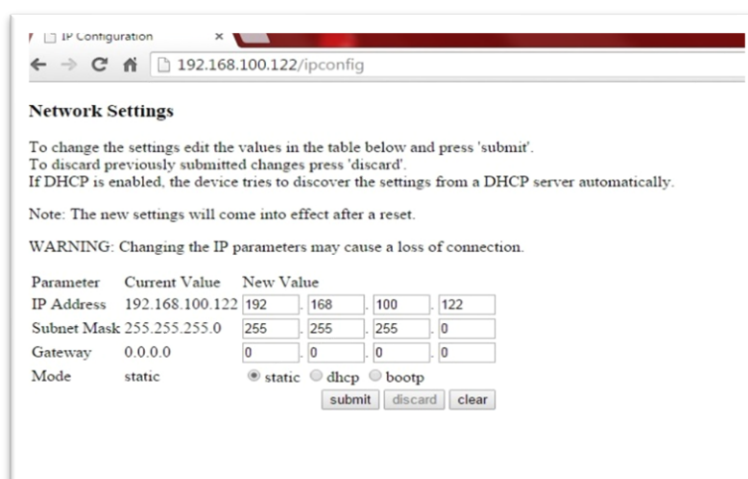

This page requires a username and password: (User/User).
For older devices, either no log in is needed or (admin/admin).

	<p>The HV generator is set <u>permanently</u> to 100 Mbit/s full duplex. The receiver should also be <u>permanently</u> set to full duplex, as the "auto-negotiation" setting responds to most bus participants to permanently full duplex with "half duplex". This leads to sporadically repeating communication malfunctions (incl. after several hours)</p>
---	--

10.2. Application interface

10.2.1. Receive I/O data mapping (EIP controller to Smart-E510)

Byte 0	Byte 1	Byte 2	Byte 3	Byte 4	Byte 5	Byte 6	Byte 7	Byte 8	Byte 9
Control word		U target value (kV)		U min (kV)		I Limit (uA)		I max (uA)	

Byte 10	Byte 11	Byte 12	Byte 13	Byte 14	Byte 15	Byte 16	Byte 17	Byte 18	Byte 19
kV ramp		Sensitivity*		Reserve					

10.2.2. I/O data mapping transfer: (Smart-E510 to EIP-Controller)

Byte 0	Byte 1	Byte 2	Byte 3	Byte 4	Byte 5	Byte 6	Byte 7	Byte 8	Byte 9
Status word				Service code		U actual (100V)		I actual (uA)	

Byte 10	Byte 11	Byte 12	Byte 13	Byte 14	Byte 15	Byte 16	Byte 17	Byte 18	Byte 19
Reserve		Sub-Version		Main-Version		HW Version		Reserve	

10.2.3. I/O data definition (area, unit, standard)

Data	Unit	Min	Max smart-E 310	Max smart-E 510	Standard	Remark
U target	kV	10	100		0	kV target value/limiting value
U min	kV	10	100		0	Limit value for Umin-switch off
I Limit*	uA	10	300	800 / 600 0-80 kV – 800 81-100 kV - 600	0	Target value for current limiting value (800 below 80 kV)
I max.*	uA	10	300	800	0	Limit value for I max - switch off
U actual	100 V	0	1095	1240	-	Actual value kV
I actual	uA	0	667	1130	-	Actual current
kV-ramp	kV/s	10	100		0	Speed when starting up voltage
Sensitivity* of the electrical arc detection		0	10		0	0: Electrical arc detection off 1~10: Highest to lowest sensitivity,
Typically this parameter can be set to 5. Do not switch off electrical arc detection in normal operation!!						

*: Valid from SW version 3.0. Of that: 550uA

Values outside of these areas (min, max) are ignored. The warning "invalid parameters" is output.

Caution: The Byte sequence is Little-Endian. The Byte sequence can be taken from the following examples:

Example: From a smart-E 510 received data:

Control word		U Target value		U min		I Limit		I _{max}	
HV ON		20 kV		5 kV		256 uA		50 uA	
Byte 0	Byte 1	Byte 2	Byte 3	Byte 4	Byte 5	Byte 6	Byte 7	Byte 8	Byte 9
0x01	0x00	0x14	0x00	0x05	0x00	0x00	0x01	0x32	0x00

kV ramp		Sensitivity*	
10 kV/s		5	
Byte 10	Byte 11	Byte 12	Byte 13
0x0a	0x00	0x05	0x00

Example: From a smart-E 510 sent data:

Status word			Service code			U actual		I actual	
						20 kV		10 uA	
Byte 0	Byte 1	Byte 2	Byte 3	Byte 4	Byte 5	Byte 6	Byte 7	Byte 8	Byte 9
0xC1	0x00	0x00	0x00	0x00	0x00	0xC8	0x00	0x0A	0x00

10.2.4. Describing the control word

Byte	Bit	Control bit	Description
0	0	High voltage ON	1: Switch on high voltage 0: Switch off high voltage
	1	Reset error	1: All errors are confirmed 0: No action Note: In order to switch on HV again, after an error has been confirmed, the "HV ON" bit must be reset/set.
	2	Reserve	
	3	Reserve	
	4	Heartbeat	The <i>smart-E</i> 310 or <i>smart-E</i> 510 expects a heartbeat signal (1Hz) via EIP-controller. This monitoring is initially deactivated and is then activated with the first heartbeat. If a heartbeat never comes, then the generator can be operated without it. As soon as the heartbeat comes once, this is monitored and if it remains off the generator shows an error.
	5	Reserve	
	6	Reserve	
	7	Relay test bit	1: Open the safety relay 0: No action / close relay Note: The safety relay is controlled by the generator depending on the remaining voltage on the HV connection. If the contact is found in the "safe" position (closed), it can be opened with this Bit for test purposes. Note: When the relay test bit is set, the HV cannot be switched on.
1	0...7	Reserve	

10.2.5. Description of the status word

Byte	Bit	Status bit	Description
0	0	HV display ON	Mirror bit of the HV EIN bit (V2.01 and higher)
	1	Reserve	
	2	Collective error / switch off	1: For error or switch off 0: No error
	3	Collective warning	1: For warning 0: No warning
	4	The high voltage is safety off. <u>CAUTION:</u> This SW bit does not fulfill the Performance Level, this is only achieved by HW feedback.	1: If the high voltage has been switched off and the output voltage has discharged to a safe level 0: If the high voltage is switched on / or the output voltage has not been discharged to a safe level 0: If a self-test error of the device has been detected
	5	Reserve	
	6	Drive power status	1: 24 V DRIVE is on 0: 24 V DRIVE is not on
	7	Monitoring contact status	1: Relay contact open 0: Relay contact closed
1	0	Heartbeat	This Bit is switched every second between 1 (logic high) and 0 (logic low) to display that the HV-supply is still active.
	1	Reserve	
	2	Reserve	
	3	Reserve	
	4	Warning: invalid parameters	1: An invalid parameter (value outside of range) has been received. 0: Parameter valid
	5	I _{max} warning	1: I actual is above 80 % of I _{max} 0: I actual is below 80 % of I _{max}
	6	Reserve	
	7	Reserve	

2	0	I _{max} switch off	1: I _{max} switch off 0: No error or error acknowledged
	1	U _{min} switch off	1: U _{min} switch off 0: No error or error acknowledged
	2	Electrical arc switch off	1: Electrical arc detected and switched off 0: No error or error acknowledged
	3	Over-voltage switch off	1: An actual value above 109 kV has been detected 0: No error or error acknowledged
	4	Communication error display	1: Heartbeat disappeared 0: No error or error acknowledged
	5	Missing DRIVE power (when HV on)	1: 24 V DRIVE is not on and HV ON has been set 0: No error or error acknowledged
	6	HV ON specification during relay test	1: HV ON was set during activated relay test (HV remains off) 0: No error or error acknowledged (V2.01 and higher)
	7	Power loss too high	1: Output power too low in relationship to the input power 0: No error or error acknowledged
3	0	Reserve	
	1	Reserve	
	2	Reserve	
	3	Reserve	
	4	Reserve	
	5	Reserve	
	6	Reserve	
	7	Self-test	1: Self-test of the smart-E 510 malfunction (program check sum, internal hardware, current measurement*) 0: No error or error acknowledged

* The check of the current measurement occurs when switching on the device (24 V CPU on), also for each high voltage switch off.

11. Specification of the EtherCAT interface

(smart-E 310t, smart-E510t, smart-E 310Dt, smart-E 510Dt)

11.1. Bus interface

EtherCAT based on the Ethernet physical layer. To create communication between the smart-E510t (EtherCAT Slave) and the controller (EtherCAT Master), the corresponding settings must be adjusted in the controller (see manual of your EtherCAT-controller for further information):

i	As smart-E510t only has an EtherCAT interface available, then it can only be positioned at the end of a connection path
----------	---

11.2. Application interface

11.2.1. ESI files

i	<p>Use our standardized "ESI" files to load the applications interface to your control software.</p> <p>ESI-files are simple text files that use network configuration tools to support the identification of products and their simple equipping in a network.</p> <p>SCHNIER provides an ESI file with all parameters and format information of the HV generator. It can be obtained on the smart-E website www.smart-E310.de.</p>
----------	---

11.2.2. Receive I/O data mapping (EtherCAT Master to Smart-E510)

Byte 0	Byte 1	Byte 2	Byte 3	Byte 4	Byte 5	Byte 6	Byte 7	Byte 8	Byte 9
Control word		U target value (kV)		U min (kV)		I Limit (uA)		I max (uA)	
Byte 10	Byte 11	Byte 12	Byte 13	Byte 14 ~ 31					
kV ramp		Sensitivity*		Reserve					

11.2.3. I/O data mapping transfer: (Smart-E510 to EtherCAT Master)

Byte 0	Byte 1	Byte 2	Byte 3	Byte 4	Byte 5	Byte 6	Byte 7	Byte 8	Byte 9
Status word				Service code		U actual (100V)		I actual (uA)	
Byte 10 ~ 15				Byte 16	Byte 17	Byte 18	Byte 19 ~31		
Reserve				Sub-Version	Main-Version	HW Version	Reserve		

11.2.4. I/O data definition (area, unit, standard)

Data	Unit	Min	Max smart-E 310	Max smart-E 510	Standard	Remarks
U target	kV	10	100		0	kV target value/limiting value
U min	kV	10	100		0	Limit value for Umin-switch off
I Limit*	uA	10	300	800 / 600 0-80 kV – 800 81-100 kV - 600	0	Target value for current limiting value (800 below 80 kV)
I max.*	uA	10	300	800	0	Limit value for I _{max} - switch off
U actual	100 V	0	1095	1240	-	Actual value kV
I actual	uA	0	667	1130	-	Actual current
kV-Rampe	kV/s	10	100		0	Speed when starting up voltage
Sensitivity* of the electrical arc detection		0	10		0	0: Electrical arc detection off 1~10: Highest to lowest sensitivity,
	Typically this parameter can be set to 5. Do not switch off electrical arc detection in normal operation!					

Values outside of these areas (min, max) are ignored. The warning "invalid parameters" is output.

Caution: The Byte sequence is Little-Endian. The Byte sequence can be taken from the following examples:

Example: From a smart-E 510 received data:

Control word		U Target value		U min		I Limit		I _{max}	
HV ON		20 kV		5 kV		256 uA		50 uA	
Byte 0	Byte 1	Byte 2	Byte 3	Byte 4	Byte 5	Byte 6	Byte 7	Byte 8	Byte 9
0x01	0x00	0x14	0x00	0x05	0x00	0x00	0x01	0x32	0x00

kV ramp		Sensitivity*	
10 kV/s		5	
Byte 10	Byte 11	Byte 12	Byte 13
0x0a	0x00	0x05	0x00

Example: From a smart-E 510 sent data:

Status word		Service code		U actual		I actual			
				20 kV		10 uA			
Byte 0	Byte 1	Byte 2	Byte 3	Byte 4	Byte 5	Byte 6	Byte 7	Byte 8	Byte 9
0xC1	0x00	0x00	0x00	0x00	0x00	0xC8	0x00	0x0A	0x00

11.2.5. Describing the control word

Byte	Bit	Control bit	Description
0	0	High voltage ON	1: Switch on high voltage 0: Switch off high voltage
	1	Reset error	1: All errors are confirmed 0: No action Note: In order to switch on HV again, after an error has been confirmed, the "HV ON" bit must be reset/set.
	2	Reserve	
	3	Reserve	
	4	Heartbeat	The <i>HS-supply</i> expects a heartbeat signal (1 Hz) via EtherCAT-controller. This monitoring is initially deactivated and is then activated with the first heartbeat. If a heartbeat never comes then the generator can be operated without it. As soon as the heartbeat comes once, this is monitored and if it remains off the generator shows an error.
	5	Reserve	
	6	Reserve	
	7	Relay test bit	1: Open the safety relay 0: No action / close relay Note: The safety relay is controlled by the generator depending on the remaining voltage on the HV connection. If the contact is found in the "safe" position (closed), it can be opened with this Bit for test purposes. Note: When the relay test bit is set, the HV cannot be switched on.
1	0...7	Reserve	

11.2.6. Description of the status word

Byte	Bit	Status bit	Description
0	0	HV display ON	Mirror bit of the HV EIN bit (V2.01 and higher)
	1	Reserve	
	2	Collective error / switch off	1: For error or switch off 0: no error
	3	Collective warning	1: For warning 0: No warning
	4	The high voltage is safety off. CAUTION: This SW bit does not fulfill the Performance Level, this is only achieved by HW feedback.	1: If the high voltage has been switched off and the output voltage has discharged to a safe level. 0: If the high voltage is switched on / or the output voltage has not been discharged to a safe level 0: If a self-test error of the device has been detected
	5	Reserve	
	6	Drive power status	1: 24 V DRIVE is on 0: 24 V DRIVE is not on
	7	Monitoring contact status	1: Relay contact open 0: Relay contact closed
1	0	Heartbeat	This Bit is switched every second between 1 (logic high) and 0 (logic low) to display that the HV-supply is still active.
	1	Reserve	
	2	Reserve	
	3	Reserve	
	4	Warning: invalid parameters	1: An invalid parameter (value outside of range) has been received. 0: parameter valid
	5	I _{max} warning	1: I actual is above 80 % of I _{max} 0: I actual is below 80 % of I _{max}
	6	Reserve	
	7	Reserve	

2	0	I _{max} switch off	1: I _{max} switch off 0: no error or error acknowledged
	1	U _{min} switch off	1: U _{min} switch off 0: no error or error acknowledged
	2	Electrical arc switch off	1: Electrical arc detected and switched off 0: no error or error acknowledged
	3	Over-voltage switch off	1: An actual value above 109 kV has been detected 0: no error or error acknowledged
	4	Communication error display	1: Heartbeat disappeared 0: no error or error acknowledged
	5	Missing DRIVE power (when HV on)	1: 24V DRIVE is not on and HV ON has been set 0: no error or error acknowledged
	6	HV ON specification during relay test	1: HV ON was set during activated relay test (HV remains off). 0: no error or error acknowledged (V2.01 and higher)
	7	Power loss too high	1: Output power too low in relationship to the input power 0: no error or error acknowledged
3	0	ESM switch off	1: HS ON request when EtherCAT is not in operational condition 0: no error or error acknowledged
	1	Reserve	
	2	Reserve	
	3	Reserve	
	4	Reserve	
	5	Reserve	
	6	Reserve	
	7	Self-test	1: Self-test of the HV-supply malfunction (program check sum, internal hardware, current measurement*) 0: no error or error acknowledged

* The check of the current measurement occurs when switching on the device (24 V CPU on), otherwise for each high voltage switch off.

12. Declaration of Conformity

Manufacturer: SCHNIER Elektrostatik GmbH
 Bayernstrasse 13
 D-72768 Reutlingen

Product: High voltage generator

Type / SCHNIER item no.: smart-E 310p / 810366, smart-E 310c / 810368, smart-E 510p / 810370,
 smart-E 510e / 810372, smart-E 510t / 810376, smart-E 310t / 810377,
 smart-E 510c / 810378, smart-E 310Dp / 810394, smart-E 510Dp / 810395,
 smart-E 510Dt / 810399, smart-E 310Dt / 810400, smart-E 310e / 810401,
 smart-E 310De / 810402, smart-E 510De / 810403

Designation:  II 2G T6
 II 2D 80°C
 PTB 15 ATEX 5018 X

We declare that the above product corresponds to the following EC Guidelines:

Directive 2014/34/EU (ATEX)
 Directive 2006/42/EC (Machine Directive)
 Directive 2004/108/EC (EMC)

The safety regulations of Directive 2014/35/EU (low voltage) were observed (see Appendix no. 1.5.1 Directive 2006/42/EC).

Related harmonized standards:

- EN 50176:2009 Stationary electrostatic application equipment for ignitable liquid coating material - Safety requirements
- EN 50177:2009 Stationary electrostatic application equipment for ignitable coating powders - Safety requirements
- EN 50223:2015 Stationary electrostatic application equipment for ignitable flock material - Safety requirements
- EN 50348:2010 Stationary electrostatic application equipment for nonignitable liquid coating material - Safety requirements
- EN ISO 12100:2010 Safety of machinery -- General principles for design -- Risk assessment and risk reduction
- EN ISO 13849-1:2008: Safety of machines - safety related parts of controls - part 1: general design guidelines
- EN 60204-1:2006/A1:2009 Safety of machinery - Electrical equipment of machines - Part 1: General requirements (IEC 60204-1:2005, modified + Supplement 1
- EN 61000-6-2:2005 Electromagnetic compatibility (EMC) - Part 6-2: Generic standards- Immunity for industrial environments
- EN 61000-6-4:2007 Electromagnetic compatibility (EMC) - Part 6-4: Generic standards- Emission standard for industrial environments

Rommelsbach 17.01.2017



Olav Schnier (Managing director)



SCHNIER Elektrostatik GmbH
Bayernstraße 13
72768 Reutlingen-Rommelsbach
Tel: +49 (0) 71 21 / 90 973-60
Fax: +49 (0) 71 21 / 90 973-99
mail@schnier-elektrostatik.de
www.schnier-elektrostatik.de